



# FUEL SYSTEMS

Boats manufactured for use in California for model year 2018 and after meet the California EVAP Emissions regulation for spark-ignition marine watercraft. Boats meeting this requirement will have a label affixed near the helm.

## WARNING

**Operating, servicing and maintaining a recreational marine vessel can expose you to chemicals including engine exhaust, carbon monoxide, phthalates, and lead, which are known to the State of California to cause cancer and birth defects or other reproductive harm. To minimize exposure, avoid breathing exhaust, service your vessel in a well-ventilated area and wear gloves or wash your hands frequently when servicing this vessel. For more information go to:  
[www.P65warnings.ca.gov/marine](http://www.P65warnings.ca.gov/marine).**

The fuel system in this boat complies with U.S. EPA mandated evaporative emission standards at time of manufacture using certified components.

# COBALT *R3* BOWRIDER



# TABLE OF CONTENTS

<b>FUEL SYSTEMS</b> .....	i
<b>GENERAL INFORMATION</b>	
WELCOME.....	1-1
CERTIFICATE OF LIMITED WARRANTY .....	1-2
ADDENDUM A – SERVICE ASSIST SERVICE AGREEMENT .....	1-3
CALIFORNIA EVAPORATIVE EMISSIONS CONTROL SYSTEM	
WARRANTY STATEMENT .....	1-4
Your Warranty Rights and Obligations .....	1-4
INTRODUCTION.....	1-6
Intended Use.....	1-6
Craft Design Category.....	1-6
OWNER RESPONSIBILITY/WARRANTY PROCEDURE .....	1-7
Before Operating .....	1-7
Warranty Service Requirements .....	1-7
If You Sell Your Cobalt Boat.....	1-7
CERTIFICATIONS .....	1-7
NMMA .....	1-7
MerCruiser.....	1-8
Volvo Penta.....	1-8
FEATURES/CONSTRUCTION .....	1-8
Amenities.....	1-8
Construction Standards/Certifications .....	1-8
Serial Number Locations .....	1-8
WARNING LABELS .....	1-9
PUBLICATIONS.....	1-12
NAUTICAL TERMS.....	1-12
SYMBOLS.....	1-15
SPECIFICATIONS .....	1-16
LAYOUT .....	1-17
PROPELLER APPLICATION CHART .....	1-18
ALPHABETICAL INDEX .....	1-19

# COBALT *R3* BOWRIDER

## RESPONSIBILITIES AND SAFETY

OWNER/OPERATOR RESPONSIBILITIES .....	2-1
Registration/Documentation .....	2-1
Required Safety Equipment .....	2-2
Recommended Safety Equipment .....	2-2
Recommended Spare Parts .....	2-3
Education Opportunities .....	2-3
Insurance .....	2-3
BOAT THEORY .....	2-3
Propulsion System .....	2-3
Remote Control System .....	2-3
Steering System .....	2-3
Fuel System .....	2-3
Ventilation System .....	2-4
Electrical Systems .....	2-4
Cooling System .....	2-5
Exhaust System .....	2-5
Lubrication System .....	2-5
Bilge .....	2-5
Seaworthiness Inspection .....	2-5
Operation Checklist .....	2-6
Environmental Considerations .....	2-6
Components, Maintenance and Repairs .....	2-8
Emergency Considerations .....	2-8
Lifesaving Equipment .....	2-11
SAFETY .....	2-13
Signal Words/Definitions .....	2-13
General Safety .....	2-14
Water Sports Safety .....	2-19
Safety Alert From August 28, 2001: .....	2-21
Navigation .....	2-21
Aids to Navigation .....	2-23

## OPERATING INFORMATION

PRECAUTIONS .....	3-1
Before You Start .....	3-1
Fire/Explosion .....	3-1
FIRST-TIME OPERATION .....	3-1
FUEL .....	3-2
Fuel Requirements .....	3-2
Fueling .....	3-2
LAUNCHING .....	3-5
Launching Checklist .....	3-5
On the Water .....	3-5
Boarding .....	3-5
Loading .....	3-5
Shipshape .....	3-5

# TABLE OF CONTENTS

GETTING UNDERWAY .....	3-6
Before Starting Checklist.....	3-6
Handling Dock and Mooring Lines .....	3-7
Starting/Shifting/Steering/Stopping .....	3-8
Basic Maneuvering.....	3-13
Environmental Considerations .....	3-19
Entertainment System .....	3-20
HELM AND INSTRUMENTATION .....	3-21
STANDARD AND OPTIONAL EQUIPMENT .....	3-28
CAPTAIN'S CHAIR ADJUSTMENTS AND OPERATION.....	3-32
HELM SEAT ELECTRIC SLIDE OPERATION (OPTIONAL).....	3-32
Helm Seat With the Electric Slide Operation.....	3-32
FLIP DOWN SWIM STEP .....	3-33
Boat in the Water.....	3-33
Boat on a Trailer.....	3-33
VOLVO PENTA OCEAN SERIES OUTDRIVE .....	3-34
WINDSHIELD LATCH.....	3-34
COCKPIT DINETTE TABLE - OPTIONAL .....	3-34
ICE CHEST .....	3-34
REMOVABLE BOW SEAT CUSHION - OPTIONAL.....	3-34
AIR COMPRESSOR - OPTIONAL.....	3-34
ANCHOR LIGHT .....	3-35
CRUISE CONTROL - OPTIONAL.....	3-35
BATTERY SWITCH .....	3-35
BATTERY CHARGER - OPTIONAL .....	3-36
AUTOMATIC CHARGING RELAY (ACR).....	3-36
FRESH WATER - OPTIONAL.....	3-36
BOW TONNEAU COVER - OPTIONAL.....	3-37
COCKPIT TONNEAU COVER - OPTIONAL .....	3-37
PREMIUM BIMINI TOP - OPTIONAL .....	3-37
PREMIUM BIMINI TOP WITH EASY FOLD - OPTIONAL .....	3-38
ECLIPSE ARCH W/BIMINI .....	3-39
ELECTRIC ECLIPSE ARCH WITH BIMINI.....	3-39
BLACK/WHITE ELECTRIC OR FOLDING ARCH WITH SUNSHADE ....	3-40
Installation .....	3-40
Removal .....	3-40
Folding the Sunshade and Arch .....	3-40
Surf Pockets.....	3-41
SS ARCH WITH BIMINI INSTRUCTIONS - OPTIONAL.....	3-41
SKI TOW EYE/PYLON.....	3-42
TIE-DOWN LOCATIONS .....	3-42
TRANSOM TILT SWITCH - OPTIONAL .....	3-43

# COBALT *R3* BOWRIDER

MOTOR BOX ASSEMBLY OR ELECTRIC MOTOR BOX ASSEMBLY .....	3-43
TOOL KIT - OPTIONAL .....	3-43
<b>SYSTEMS</b>	
INTRODUCTION.....	4-1
FUEL ROUTING .....	4-2
WATER/PLUMBING .....	4-3
Fresh Water .....	4-3
Water System.....	4-4
FIRE SUPPRESSION EQUIPMENT.....	4-4
ELECTRICAL SYSTEM .....	4-4
CIRCUIT BREAKER PANEL.....	4-5
FUSES .....	4-6
BATTERY CONNECTIONS .....	4-6
<b>INTERIOR/EXTERIOR CARE</b>	
VINYL INTERIOR AND UPHOLSTERY .....	5-1
Care and Cleaning of Vinyl .....	5-1
SEA GRASS FLOOR COVERING CLEANING INSTRUCTIONS .....	5-2
General Maintenance Instructions .....	5-2
Maintenance Techniques .....	5-2
Spot and Stain Removal .....	5-4
CABINETRY AND WOOD .....	5-5
Cabinetry .....	5-5
Woodgrain Dash .....	5-5
Teak Swim Platform .....	5-5
Cedar .....	5-5
CARPET.....	5-5
DECK AND HULL .....	5-5
Cleaning Deck and Hull.....	5-5
Deck and Hull Care .....	5-6
Swim Platform Mat Care and Maintenance.....	5-6
STAINLESS STEEL AND CHROME .....	5-7
Preventive Steps .....	5-7
Cleaning Stainless Steel .....	5-7
CORROSION PROTECTION .....	5-7
CorrosionX .....	5-7
Topside .....	5-7
Inside the Bulkhead.....	5-8
Other Areas .....	5-8
Galvanic Corrosion.....	5-8
Salt Water .....	5-8
CANVAS .....	5-9
Cleaning Canvas .....	5-9
Special Cleaning Problems .....	5-9

# TABLE OF CONTENTS

OTHER CANVAS COMPONENTS .....	5-10
Clear Vinyl “Isinglass” .....	5-10
Zippers .....	5-10
Snap Fasteners .....	5-10
WINDSHIELD .....	5-10
BILGE .....	5-10
MARINE GROWTH .....	5-10
STATIONARY ARCH WITH AWLGRIP TOPCOAT .....	5-11
<b>MAINTENANCE AND TROUBLESHOOTING</b>	
SCHEDULED MAINTENANCE AND SERVICE .....	6-1
Maintenance Schedule .....	6-1
Break-In .....	6-2
Before Each Use .....	6-2
Every 50 Hours .....	6-2
Every 100 Hours .....	6-3
Monthly .....	6-3
Quarterly .....	6-3
UNSCHEDULED MAINTENANCE .....	6-3
Engine/Propulsion/Cooling System .....	6-3
Electrical System .....	6-3
Fuel System .....	6-4
Water System (if equipped) .....	6-4
LIFTING THE BOAT .....	6-4
Using Lifting Slings .....	6-4
Storage Cradle .....	6-5
STORAGE/WINTERIZATION .....	6-5
Reactivating the Boat After Storage .....	6-6
Cockpit Heater .....	6-6
TROUBLESHOOTING .....	6-7
Engine .....	6-7
Electrical .....	6-9
Plumbing .....	6-9
<b>REFERENCE AND FORMS</b>	
OPERATION QUICK REFERENCE .....	7-1
Before Launching .....	7-1
Pre-Operation .....	7-1
Starting Engines .....	7-2
Casting Off .....	7-2
During Operation .....	7-2
Returning to Port .....	7-2
Stopping the Engines .....	7-2
After Boating .....	7-2
SERVICE LOG .....	7-3
FUEL LOG .....	7-4
FLOAT PLAN .....	7-5
BOAT INFORMATION .....	7-6
WARRANTY TRANSFER FORM .....	7-7

# COBALT *R3* BOWRIDER

## NOTES





# GENERAL INFORMATION

## WELCOME

Dear New Cobalt Owner,

From all of us at the factory and from your authorized Cobalt dealer, thank you for purchasing a Cobalt boat. We greatly appreciate your business and look forward to a long and enjoyable relationship with you as part of the Cobalt family.

This manual is designed to help you maximize the enjoyment of your Cobalt boat, and to acquaint you with proper operation, care, storage and maintenance of your investment.

Even if you're a seasoned boater and have previously owned a Cobalt boat, I recommend you take time to read through this Owner's manual. As you read this manual, please remember that "common sense" and "courtesy" are the most valuable traits you can have to fully enjoy safe boating. It is also to your personal advantage to become well acquainted with the rules and general "know how" of boating.

For service and for assistance, contact your authorized Cobalt dealer. The dealership staff will be happy to answer questions concerning maintenance, warranty or any other operational questions you may have about your Cobalt boat.

All the best in boating,

A handwritten signature in black ink, appearing to read 'Paul St. Clair', with a long horizontal flourish extending to the right.

Paul St. Clair, Chairman and C.E.O.

## CERTIFICATE OF LIMITED WARRANTY

Subject to the terms, conditions, and exclusions in this warranty, Cobalt Boats, LLC, a Delaware limited liability corporation doing business as Cobalt Boats (“Cobalt”), warrants to the original retail purchaser (and any subsequent owner) (“Owner”) of a new Cobalt boat purchased from an authorized Cobalt dealer for personal, non-racing and non-commercial use, as follows:

**Ten (10) Year Limited Transferable Warranty on Hull and Deck.** Cobalt warrants to the Owner that the hull and deck including floor, stringers, bulkheads, motor mounts, transom and deck/hull joints of a new Cobalt boat are free from structural defects in material and workmanship under normal, non-racing and non-commercial use for a period of ten (10) years from the date of delivery to the original retail purchaser.

**Five (5) Year Limited Transferable Bow to Stern Component Warranty.** Cobalt warrants that the upholstery, canvas, components (excluding hull and deck structural components), whether purchased or manufactured by Cobalt, with respect to a new Cobalt boat are free from structural defects in material and workmanship under normal, non-racing and non-commercial use for a period of five (5) years from the date of delivery to the original retail purchaser.

**Three (3) Year Limited Transferable Warranty on Gelcoat Finish.** Cobalt warrants that the gelcoat finish, with respect to a new Cobalt boat are free from defects in material and workmanship under normal, non-racing and non-commercial use for a period of three (3) years from the date of delivery of such Cobalt boat to the original retail purchaser. Because local area operating conditions and customer care have an effect on gelcoat finishes, the gelcoat finish warranty does not cover (1) damage or deterioration (for example: fading, oxidation, discoloration) due to in-water storage or improper care of the gelcoat surface; or (2) deterioration (for example: fading, oxidation, discoloration) to the gelcoat finish of any Cobalt boat with colored (non-white) gelcoat located below the static waterline; or (3) blisters due to in-water storage without the proper application of a marine barrier coating to the bottom of the hull.

**THERE ARE NO EXPRESS WARRANTIES OTHER THAN THE ABOVE LIMITED EXPRESS WARRANTIES. TO THE EXTENT APPLICABLE, ANY IMPLIED WARRANTIES, INCLUDING ANY IMPLIED WARRANTIES OF MERCHANTABILITY OR FITNESS FOR PARTICULAR PURPOSE, WILL NOT EXTEND BEYOND THE DURATION OF THESE EXPRESS WRITTEN WARRANTIES.**

Some states do not allow limitations on how long an implied warranty lasts, so the above limitation may not apply to you.

**Exclusions.** The above described limited warranties do not apply (1) if such Cobalt boat has been used at any time commercially, industrially, for racing or other competition or for revenue producing purposes; (2) to engines, outdrives, propellers, controls (each of which may be separately warranted by the engine manufacturer thereof); (3) engines, outdrives, propellers, controls, batteries, trailers, equipment or accessories installed by persons or parties other than Cobalt or an authorized Cobalt dealer; (4) windshield leakage, rainwater leakage, windshield or window damage or breakage; (5) deterioration or damage, fading or shrinkage of upholstery, carpet or canvas; (6) damage related to the alteration or modification of such Cobalt boat with any structurally affecting addition, component or accessory not specifically in accordance with Cobalt’s specifications or offered as an option by Cobalt; (7) damage, deterioration (for example: fading, oxidation, corrosion) of surface finishes, vinyls, fabrics, aluminum and stainless steel finishes; (8) damage or failures caused by operation of the Cobalt boat outside of the maximum horsepower specifications recommended by Cobalt; (9) damage or failure related to repairs made by any service provider not approved by Cobalt; (10) damage (for example: scratches, fading, oxidation, discoloration) to the gelcoat finish; (11) deterioration (for example: fading, oxidation, discoloration) to the gelcoat finish of any Cobalt boat with colored (non-white) gelcoat located below the static waterline; or (12) damage or failure related to alteration, modification, misuse, neglect, negligence, accident or failure to provide reasonable care and maintenance of such Cobalt boat.

# GENERAL INFORMATION

## **Remedies.**

**General.** During the applicable limited warranty period, as set forth above, covered warranty repairs shall be made and any replacement parts or components used as part of such warranty repairs shall be provided without charge by an authorized Cobalt dealer or, at the option of Cobalt, by Cobalt at its plant in Neodesha, Kansas or at a facility specifically authorized by Cobalt. All warranty repairs and replacement parts or components shall be subject to the authorization of factory trained personnel of Cobalt. Transportation to and from an authorized Cobalt dealer, and/or to and from the Cobalt plant in Neodesha, Kansas, for warranty repairs, shall be at Owner's expense.

**Service Assist Service Agreement (see Addendum A).** Service Assist is not covered under this limited warranty. Service Assist is covered under the separate Service Assist Service Agreement.

The rights and benefits granted under the above described limited warranty extend to (1) the original retail purchaser of a new Cobalt boat, and (2) any owner of such Cobalt boat during the applicable warranty period, commencing with the date of delivery of such Cobalt boat to the original retail purchaser, provided that such limited warranty is validated, as set forth herein. **COBALT'S ONLY RESPONSIBILITY, AND THE OWNER'S ONLY REMEDY, IS AS DESCRIBED IN THIS WARRANTY. COBALT SHALL NOT BE LIABLE FOR INCIDENTAL, CONSEQUENTIAL, INDIRECT OR SPECIAL DAMAGES.**

Some states do not allow the exclusion or limitation of incidental or consequential damages, so the above exclusions may not apply to you. This warranty gives you specific legal rights, and you may also have other legal rights which vary from state to state.

**How to obtain Warranty Service.** To validate the above described limited warranty, (1) the authorized Cobalt dealer must complete the warranty registration process with Cobalt Boats at 1715 N. 8th Street, Neodesha, KS 66757, within ten (10) days after purchase of a new Cobalt boat, and (2) any subsequent owner of a Cobalt boat during the applicable limited warranty period must give written notice of the acquisition of a Cobalt boat to Cobalt within ten (10) days after such purchase. Notification of any warranty claim arising within the applicable warranty period, as set forth above, must be made in writing by the owner of such Cobalt boat or by an authorized Cobalt dealer to Cobalt within thirty (30) days after the discovery of the alleged basis for any warranty claim. With respect to any condition for validating a limited warranty or obtaining any remedy, the authorized Cobalt dealer is Owner's agent, and Owner is solely responsible for and bears the risk for the authorized Cobalt dealer's failures.

## **ADDENDUM A – SERVICE ASSIST SERVICE AGREEMENT**

In consideration of the purchase of a new Cobalt boat from an authorized Cobalt dealer for personal, non-racing, and non-commercial use, for the term of this agreement Cobalt Boats, LLC ("Cobalt") agrees to provide to the original retail purchaser or any subsequent owner (each an "Owner") of such Cobalt boat, for which the registration process under Cobalt's Certificate of Limited Warranty has been completed, the services described in this agreement.

**Obligation.** Subject to the conditions and limitation of this agreement, if (1) Owner makes a valid claim under either the Cobalt Five (5) Year Bow to Stern Component Warranty or any express warranty made by the engine manufacturer with respect to the engine or powertrain of such new Cobalt boat (the "Applicable Warranties"); (2) Owner incurs costs for on-water towing, hoist/lift-out, haul-out, or dockside repair call ("Covered Services") in association with such claim; and (3) the Applicable Warranties claim is made and Covered Services costs are processed through an authorized Cobalt dealer ("Dealer"), then Cobalt will reimburse Owner for or pay such costs.

**Conditions.** As a condition for Cobalt's obligations under this agreement, if Covered Services are provided by anyone other than a Dealer, Owner must provide the following documentation (as applicable) to the Dealer prior to the time the Dealer submits the Applicable Warranty claim:

- Copy of Towing, Hoist/Lift out, Haul-Out or Dockside Repair bill
- Copy of warranty claim to the engine manufacturer

**Limitations.** Cobalt's liability under this agreement will not exceed a maximum of \$100 per claim. EXCEPT AS PROHIBITED BY APPLICABLE LAW, COBALT MAKES NO WARRANTIES, EXPRESS OR IMPLIED, UNDER THIS AGREEMENT OR REGARDING THE SERVICES, INCLUDING WITHOUT LIMITATION, THE IMPLIED WARRANTIES OF MERCHANTABILITY OR FITNESS FOR A PARTICULAR PURPOSE. COBALT WILL NOT BE LIABLE FOR INCIDENTAL, CONSEQUENTIAL, INDIRECT OR SPECIAL DAMAGES. Some states do not allow the exclusion or limitation of implied warranties or limitation of remedies for their breach, so the above provision may not apply to you. This agreement gives you specific legal rights, and you may also have other legal rights which vary from state to state.

**Term.** This agreement begins on the original purchaser delivery date of the new Cobalt boat and is effective through the end of the warranty periods for the Applicable Warranties.

**Assignment.** This agreement is transferable to subsequent Owners within the term of this agreement. Otherwise, Owner may not transfer or assign any of Owner's right, title, or interest under this agreement.

**General.** This agreement embodies the entire understanding of the parties. This agreement cannot be changed or modified except in writing signed by an authorized officer of Cobalt. This agreement is governed by the laws of the State of Kansas, ignoring the rules on conflicts of law. No failure or delay by Cobalt to exercise any right or remedy will operate as a continuing waiver. Headings used in this agreement will have no legal significance. This agreement will not be construed against a party simply because the party may have drafted such provision.

## **CALIFORNIA EVAPORATIVE EMISSIONS CONTROL SYSTEM WARRANTY STATEMENT**

### **Your Warranty Rights and Obligations**

The California Air Resources Board is pleased to explain the evaporative emission control system's warranty on your 2018 Boat. In California, new spark-ignition marine watercraft (SIMW) must be designed, built, and equipped to meet the State's stringent anti-smog standards. Cobalt Boats, LLC must warrant the evaporative emission control system on your boat for the period listed below provided there has been no abuse, neglect or improper maintenance of your SIMW.

Your evaporative emissions control system may include parts such as: canisters, carburetors, clamps, connectors, filters, fuel caps, fuel lines, fuel tanks, valves, vapor hoses, and other associated evaporative emissions control system components.

### **MANUFACTURER'S WARRANTY COVERAGE:**

This evaporative emission control system is warranted for two years. If any evaporative emission-related part on your SIMW is defective, the part will be repaired or replaced by Cobalt Boats, LLC.

# GENERAL INFORMATION

## OWNER'S WARRANTY RESPONSIBILITIES:

- As the boat owner, you are responsible for performance of the required maintenance listed in your owner's manual. Cobalt Boats, LLC recommends that you retain all receipts covering maintenance on your boat, but Cobalt Boats, LLC cannot deny warranty solely for the lack of receipts.
- As the boat owner, you should however be aware that Cobalt Boats, LLC may deny you warranty coverage if your spark-ignition marine watercraft or a part has failed due to abuse, neglect, or improper maintenance or unapproved modifications.
- You are responsible for presenting your boat to a Cobalt Boat, LLC distribution center or service center as soon as the problem exists. The warranty repairs should be completed in a reasonable amount of time, not to exceed 30 days. If you have a question regarding your warranty coverage, you should contact Cobalt Boats, LLC at 1-(620) 325-2653.

The California evaporative emissions control system warranty covers the following list of components:

- |                                     |  |
|-------------------------------------|--|
| (1) Canister Mounting Brackets      | (11) Fuel Line   |
| (2) Carbon Canister                 | (12) Fuel Line Fittings  |
| (3) Carburetor Purge Port Connector | (13) Fuel Tank   |
| (4) Clamps*                         | (14) Liquid/Vapor Separator  |
| (5) Control Cables*                 | (15) Pressure Relief Valves*   |
| (6) Control Linkages*               | (16) Purge Valves  |
| (7) Control Solenoids*              | (17) Vacuum Control Diaphragms*  |
| (8) Control Valves*                 | (18) Vapor Hoses   |
| (9) Electronic Controls*            | (19) All other parts not listed that may affect the evaporative emissions control system |
| (10) Fuel Cap                       |  |

\* Your craft may or may not be equipped with these components.

## INTRODUCTION

This manual was created following International Organization for Standards (ISO) 10240:2004 as a guideline. Not all information to conform to the standards set forth by ISO can be included in this manual without certain manufacturer's consent of the equipment included on your boat.

This owner's manual contains information that is necessary to run the boat properly, safety topics, and operation and maintenance hints.

Even if everything has been planned and designed for the safety of the boat and its users, boating is highly dependent on the weather conditions, the sea state, and the experience and physical shape of the crew, and one can never ensure full safety. It is your responsibility as the owner or user to know the boat's equipment, its capabilities and the boat's intended use.

The specific information on the operation of the equipment and systems your boat is supplied with or fitted with should be supplied by that manufacturer. Read, understand and keep all the information supplied, and familiarize yourself and all users with the boat before you put it into use.

All persons should wear a suitable life preserver/personal flotation device when on deck. In some countries it is a legal requirement to wear a suitable life preserver/personal flotation device that complies with those countries' regulations at all times.

### WARNING

**Avoid serious injury or death.**

- **Children, disabled people and non-swimmers should wear a personal flotation device at all times. Children and non-swimmers need special instruction in the use of life preservers. Inform all passengers on the proper use of personal flotation devices and of the location of safety equipment, man overboard recovery equipment, and the location and deployment of the ladder.**
- **Avoid contact with any running machinery moving parts, such as an engine, generator or propeller. Contact can result in loss of body parts, strangulation, burns and/or severe loss of blood. Keep all machinery guards in place when machinery is operating.**

### Intended Use

Your Cobalt boat is intended for use as a pleasure and sport craft.

### Craft Design Category

Significant Wave Height – is the mean height of the highest one-third of the waves, which approximately corresponds to the wave height estimated by an experienced observer. Some waves will be double this height.

### OCEAN – Category A

Craft designed to operate in winds that may exceed wind Beaufort force 8 and in significant wave heights of 13' 1.44" (4 m) and above, and is largely self-sufficient. Abnormal conditions such as hurricanes are excluded. Such conditions may be encountered on extended voyages, for example across oceans, or inshore when unsheltered from the wind and waves for several hundred nautical miles.

# GENERAL INFORMATION

## **OFFSHORE – Category B**

Craft designed to operate in winds up to Beaufort force 8 and the associated wave heights and in significant wave heights up to 13' 1.44" (4 m). Such conditions may be encountered on offshore voyages of sufficient length, or on coastal waters when unsheltered from the wind and waves for several dozens of nautical miles. These conditions may also be experienced on inland seas of sufficient size for the wave height to be generated.

## **INSHORE – Category C**

Craft designed to operate in winds up to Beaufort force 6 and the associated wave heights and significant wave heights up to 6' 6.7" (2 m). Such conditions may be encountered in exposed inland waters, in estuaries and in coastal waters in moderate weather conditions.

## **SHELTERED WATERS – Category D**

Craft designed to operate in winds up to Beaufort force 4 and the associated wave heights (occasional maximum waves of 1' 7.7" [0.5 m] height). Such conditions may be encountered in sheltered inland waters, and in coastal waters in fine weather.

## **OWNER RESPONSIBILITY/ WARRANTY PROCEDURE**

### **Before Operating**

Before operating your new Cobalt boat, it is necessary that you read and understand this manual. Also, take the time to read the other component manuals supplied to you in your owner's packet.

### **Warranty Service Requirements**

All Cobalt warranty service must be completed by an authorized Cobalt dealer. If you are not able to return your boat to your selling dealership, you must contact him so he may assist you in coordinating the warranty repairs. Any claims against Cobalt Boats without prior approval from Cobalt Boats on repairs completed by an unauthorized dealership may be denied.

### **If You Sell Your Cobalt Boat**

Your warranties are transferable. If you sell your Cobalt boat to anyone other than an authorized Cobalt dealer, please refer to the Warranty Transfer Form on the last page of this manual. If the proper transfer procedures are not followed, future warranty may be denied.

## **CERTIFICATIONS**

### **NMMA**

Cobalt Boats is a member of the National Marine Manufacturers Association (NMMA). This independent organization's members include boat, engine and marine equipment manufacturers that are focused on the improvement and safety of boating.

Your new Cobalt boat is NMMA certified. An NMMA certification not only satisfies the U.S. Coast Guard (USCG) regulations but also the more rigorous equipment and system standards based on those established by the American Boat and Yacht Council, Inc. (ABYC). Your Cobalt boat meets or exceeds NMMA safety-based certifications.

Cobalt Boats has made a significant contribution to the boating industry by successfully completing the Mercury MerCruiser® propulsion-installation quality certification program and the Volvo Penta Certified OEM Program.

### **MerCruiser**

The MerCruiser Program partners boat builders with MerCruiser to improve product quality and enhance boating-enthusiast satisfaction. The certification program is designed to review all facets of manufacturing and installation processes and to identify opportunities to implement Lean Six Sigma processes and training programs. Key areas of focus include assembly and component specifications, propulsion-installation processes and industry-standard end-of-line test procedures.

### **Volvo Penta**

The Volvo Penta Program requires the boat builder commitment to follow the established training requirements, installation procedures and documentation processes throughout the engine installation and testing process. Ultimately, the goal of the program is to improve integrated product quality and customer satisfaction as well as to reduce warranty visits and costs.

## **FEATURES/CONSTRUCTION**

### **Amenities**

Your Cobalt boat incorporates classic styling with the long, clean lines that have defined Cobalt design for over 40 years.

Performance features include a hand-laid reinforced Kevlar with an all-fiberglass stringer system and AME 1000 vinylester resins used on the deck and hull for superior strength, toughness and weight savings.

### **Construction Standards/Certifications**

A Warranty Statement explaining terms and conditions is supplied in this section. Please familiarize yourself with this statement. Failure to follow operating instructions and proper maintenance can void the warranty.

Construction Standards detailing industry standards followed in building your Cobalt boat are explained in this section. Please contact your authorized Cobalt dealer for additional construction information.

### **Serial Number Locations**

Your Cobalt boat, its engines and propulsion units, and other equipment onboard will have a serial number for identification. It is a good practice to prepare a list of all serial number items and store it in a safe place other than onboard the boat. A page is supplied at the end of this manual for this purpose. The Hull Identification Number (HIN) is located on the upper starboard side of the transom. Please refer to the equipment operator's manuals supplied in your owner's packet for location of serial numbers.



# GENERAL INFORMATION

## WARNING LABELS

The warning labels on your Cobalt boat must remain legible. If a label is damaged or you suspect a label is missing, contact your authorized Cobalt dealer for immediate replacement.

There are several labels used to point out hazards. All of these labels shown may not be included on your boat. The general location of the labels is as follows:

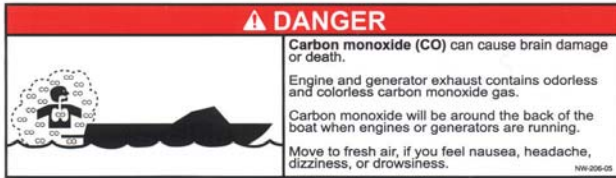

Transom of Boat

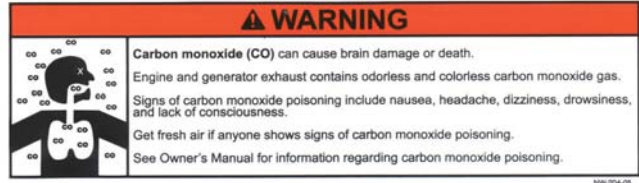

Helm

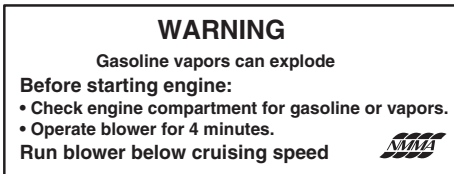

Helm

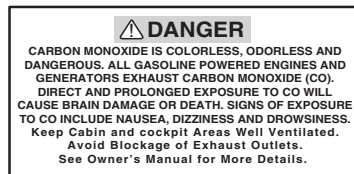

Helm and Cabin

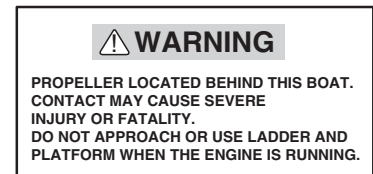

Transom of Boat

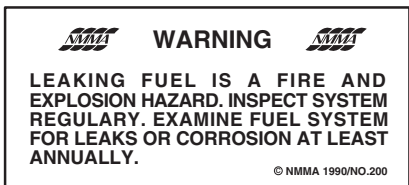

Engine Compartment



Unvented Storage Areas



Cabin Door

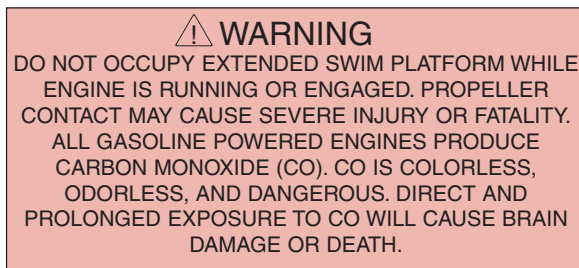

Extended Swim Platform

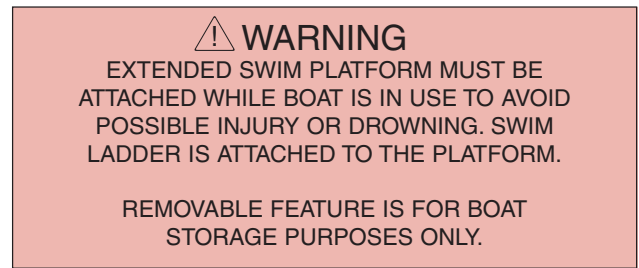

Extended Swim Platform

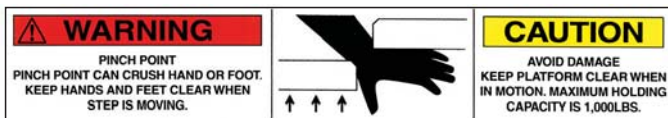

Hydraulic Swim Platform

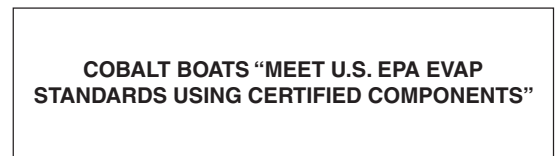

Helm (U.S. Only)

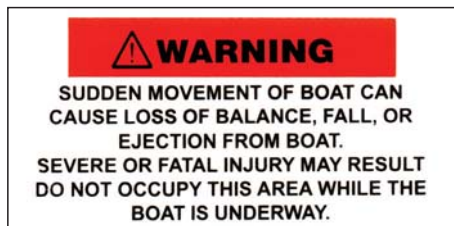

Aft Sun Pad

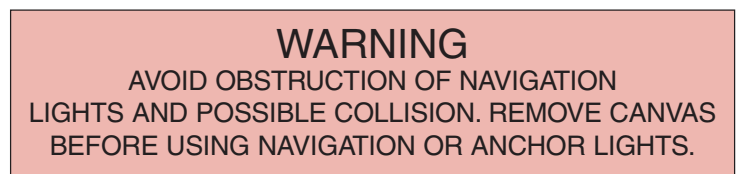

Navigation Light

COB\_0018\_A

## WARNING

This tower is designed to tow a wakeboarder. Do not tow other boats, tubes, parasails, etc. Do not climb, jump or dive off the tower. Do not sit behind the tower where you could come in contact with the rope. Do not allow loose ropes to hang from the tower. Do not trailer the boat with boards or skis in the racks. Before and during each use make sure all bolts and fasteners are tight. Make sure you have sufficient clearance above the tower when it is up. Watch for bridges, power lines, tree limbs and other low hanging obstacles. Failure to follow these instructions can lead to serious injury or death.

Eclipse Arch



## WARNING

Keep hands and feet away from drive unit when tilting.

Transom of Boat



## WARNING

**AVOID SERIOUS INJURY OR DEATH FROM FIRE, EXPLOSION OR ELECTRICAL SHOCK.**

- This device must be connected to a Ground Fault Circuit Interrupter (GFCI) Protected AC outlet.
- When using an extension cord, connect charger AC plug before connecting to the GFCI protected AC outlet.
- Make connection in an open atmosphere free of explosive fumes.
- Make connection in a secure manner that will avoid contact with water.

Battery Charger

## CAUTION

**TO PREVENT EQUIPMENT DAMAGE DO NOT OPERATE GENERATOR ABOVE 40 MPH**

Engine Compartment, Generator

## WARNING!

**SECURE DOOR WHEN CRUISING**  
DO NOT SIT, STAND, OR PLACE HEAVY OBJECTS ON DOOR.  
KEEP CABIN DOOR CLOSED WHEN ENGINES OR GENERATOR ARE RUNNING.  
DO NOT USE CAUSTIC MATERIALS TO CLEAN.  
WASH WITH MILD SOAP AND WATER.

Cabin Door

## COBALT CHECK LIST

For maximum enjoyment and safety, check each of these items BEFORE you start your engine:

- DRAIN PLUG (securely in Place?)
- LIFE-SAVING DEVICES (One for every person on board?)
- STEERING SYSTEM (Working smoothly and properly?)
- FUEL SYSTEM (Adequate fuel? Leaks? Fumes?)
- BATTERY (Fully charged? Proper water level)
- ENGINE (In neutral?)
- CAPACITY PLATE (Are you overloaded or overpowered?)
- WEATHER CONDITIONS (Safe to go out)
- ELECTRICAL EQUIPMENT (Lights, horn, pump, etc?)
- EMERGENCY GEAR (Fire extinguisher, bailer, paddle, anchor and line, signaling device, tool kit, etc?)

## RECOMMENDED SAFETY RULES

- REMAIN SEATED WHILE UNDERWAY
- AVOID USING REAR PAD OR SUNDECK WHILE ENGINE IS RUNNING
- DO NOT USE BOARDING LADDER WHILE ENGINE IS RUNNING
- TURN OFF ENGINE AND ALL ELECTRICAL SYSTEMS WHILE RE-FUELING
- TURN OFF ENGINE WHEN SWIMMERS ARE NEAR BOAT

Helm

## CAUTION

**MOVING MACHINERY POTENTIAL DAMAGE OUTDRIVE WILL LOWER BEFORE SWIM PLATFORM DESCENDS**

Above Hydraulic Swim Platform Switch



## WARNING

**To minimize shock and fire hazards:**

- (1) Turn off the boat's shore connection switch before connecting or disconnecting shore cable
- (2) Connect shore power cable at the boat first.
- (3) If polarity warning indicator is activated, immediately disconnect cable.
- (4) Disconnect shore power cable at shore outlet first.
- (5) Close shore power inlet cover tightly.

**DO NOT ALTER SHORE POWER CABLE CONNECTORS**

Shore Power Connection

## CAUTION

TO AVOID INJURY, GLASS DOOR MUST BE SECURED IN A CLOSED AND LOCKED POSITION WHEN BOAT IS UNDER WAY. USE BOTH TURN LOCKS TO SECURE DOOR.

Walk-Through Door/Windshield

## CAUTION

**FOOT CAN SLIP THROUGH RUNG CAUSING BODILY INJURY, CLOSE CABIN DOOR BEFORE USING FORE DECK LADDER**

Companionway Area

## DISCHARGE OF OIL PROHIBITED

THE FEDERAL WATER POLLUTION CONTROL ACT PROHIBITS THE DISCHARGE OF OIL OR WASTE INTO OR UPON THE NAVIGABLE WATER OF THE UNITED STATES OR THE WATERS OF THE CONTIGUOUS ZONE IF SUCH DISCHARGE CAUSES A FILM OR SHEEN UPON OR A DISCOLORATION OF THE SURFACE OF THE WATER OR CAUSE A SLUDGE OR EMULSION BENEATH THE SURFACE OF THE WATER VIOLATORS ARE SUBJECT TO A PENALTY OF \$5000.

Engine Compartment

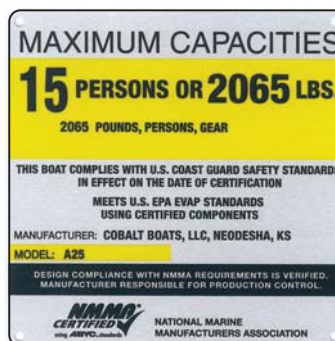

Helm  
(actual capacity varies by model)



NW501-05

## WARNING

A wide variety of components used on this vessel contain or emit chemicals known to the State of California to cause cancer and birth defects and other reproductive harm.

### EXAMPLES INCLUDE:

- Engine and generator exhaust
- Engine and generator fuel, and other liquids such as coolants and oil, especially used motor oil.
- Cooking fuels.
- Cleaners, paints, and substances used for vessel repair.
- Waste materials that result from wear of vessel components.
- Lead from battery terminals and from other sources such as ballast or fishing sinkers.

### TO AVOID HARM:

- Keep away from engine, generator, and cooking fuel exhaust fumes.
- Wash areas thoroughly with soap and water after handling the substances above.

California Health & Safety Code §§ 25249.5-13





Helm (California Only)

COB\_0019\_A

# GENERAL INFORMATION

**It is illegal for any vessel to dump plastic trash *anywhere* in the ocean or navigable waters of the United States. Annex V of the MARPOL TREATY is an**

**International Law for a cleaner, safer marine environment. Violation of these requirements may result in civil penalty up to \$25,000, fine and imprisonment.**

 U.S. Lakes, Rivers, Bays, Sounds and 3 miles from shore <b>ILLEGAL TO DUMP Plastic &amp; Garbage</b> Paper Metal Rags Crockery Glass Dunnage Food	 3 to 12 miles <b>ILLEGAL TO DUMP Plastic</b> Dunnage, lining & packing materials that float, also if not ground to less than one inch: Paper Crockery Rags Metal Glass Food	 12 to 25 miles <b>ILLEGAL TO DUMP Plastic</b> Dunnage, lining & packing materials that float	 Outside 25 miles <b>ILLEGAL TO DUMP Plastic</b>
	State and local regulations may further restrict the disposal of garbage.		

Helm  
(Boats 26' and over)

**NOTE: ON OCCASION, YOU MAY HAVE TO CLEAR THE PILE OF ROPE FROM UNDER THE HAWSE PIPE TO MAKE ROOM FOR THE REMAINING ROPE.**

Near Windlass, Where Applicable

**ATTENTION**

WHEN USING SURF SYSTEM, TURN OFF POWER TRIM ASSIST (PTA) LOCATED ON CONTROL LEVER.  
PTA MAY CAUSE UNDESIRED SURF SYSTEM OPERATION

Starboard, W/S Wing  
(R3, R5, R7 only)

COB\_0435\_A

## PUBLICATIONS

Your owner's packet includes information about onboard systems and equipment furnished by suppliers other than Cobalt Boats. Please refer to these manufacturer's manuals for additional operation and maintenance instructions not covered in this manual.

## NAUTICAL TERMS

**ABOARD** – On or in the boat.

**ABYC** – American Boat and Yacht Council, Inc.

**AFLOAT** – On the water.

**AFT** – Toward the rear or stern of the boat.

**AGROUND** – Touching bottom.

**AMIDSHIP** – Center or middle of the boat.

**ANCHOR** – (1) An iron casting shaped to grip the lake bottom to hold the boat. (2) The act of setting the anchor.

**ASHORE** – On the shore.

**ASTERN** – Toward the stern.

**BAIL** – To remove water from the bottom of the boat with a pump, bucket, sponge, etc.

**BEAM** – The widest point on the boat.

**BEARING** – Relative position or direction of an object from the boat.

**BILGE** – The lowest interior section of the boat hull.

**BOARDING** – To enter the boat.

**BOUNDARY WATERS** – A body of water between two areas of jurisdiction; i.e., a river between two states.

**BOW** – The front of the boat.

**BULKHEAD** – Vertical partition (wall) in a boat.

**BUNKS** – Carpeted trailer hull supports.

**BURDENED BOAT** – Term for the boat that must "give-way" to boats with the right-of-way.

**CAPACITY PLATE** – A plate that provides maximum weight capacity and engine horsepower rating information. It is located in full view of the helm.

**CAPSIZE** – To turn over.

**CAST-OFF** – To unfasten mooring lines in preparation for departure.

**CENTER LINE** – A lengthwise imaginary line which runs fore and aft with the boat's keel.

**CHINE** – The point on a boat where the side intersects (meets) the bottom.

**CLEAT** – A deck fitting with ears to which lines are fastened.

**CONSOLE** – Also called helm. The steering wheel area of the boat.

**CRANKING BATTERY** – The main battery used for engine starting and electrical circuits.

**CURRENT** – Water moving in a horizontal direction.

**DECK** – The open surface on the boat where the passengers walk.

**DEEP CYCLE BATTERIES** – Special long-running batteries which can be repeatedly discharged and recharged without significant loss of power.

**DOLLY WHEEL** – A rolling jack assembly at the front of the trailer used for positioning the coupler during trailer hookup.

**DRAFT** – The depth of the boat below the water line, measured vertically to the lowest part of the hull.

**ELECTROLYSIS** – The break-up of metals due to the effects of galvanic corrosion.

**EPIRB** – Emergency Position Indicating Radio Beacon.

**FATHOM** – Unit of depth or measure; 1 fathom equals 6 feet.

**FENDERS** – Objects placed alongside the boat for cushioning. Sometimes called bumpers.

# GENERAL INFORMATION

**FORE** – Toward the front or bow of the boat. Opposite of aft.

**FREEBOARD** – The distance from the water to the gunwale.

**FUEL SENDING UNIT** – The electrical device that is mounted on the outside of a built-in fuel tank and controls the dashboard fuel gauge.

**GIVE-WAY BOAT** – (1) Term for the boat that must take whatever action necessary to keep well clear of the boat with the right-of-way in meeting or crossing situations. (2) The burdened boat.

**GUNWALE** – The rail or upper edge of a boat's side.

**HEAD** – A marine toilet.

**HELM** – The steering wheel or command area.

**HULL** – The body of the boat.

**HYPOTHERMIA** – A physical condition where the body loses heat faster than it can produce it.

**IN-LINE FUSE** – A type of protective fuse located in the power wire of a direct current (DC) circuit usually near the battery.

**KEEL** – The lowest portion of the boat; extends fore and aft along the boat's bottom.

**LIST** – Leaning or tilt of a boat toward the side.

**LOA** – Length overall.

**MAKING WAY** – Making progress through the water.

**MARINE CHART** – Seagoing maps showing depths, buoys, navigation aids, etc.

**MOORING** – An anchor, chain, or similar device that holds a boat in one location.

**NAVIGATION AID** – Recognizable objects on land or sea such as buoys, towers or lights which are used to fix position to identify safe and unsafe waters.

**NMMA** – National Marine Manufacturers Association.

**NO-WAKE SPEED** – The speed at which a boat travels to produce an imperceptible wake.

**PFD** – Personal flotation device.

**PITOT TUBE** – See SPEEDOMETER PICKUP TUBE.

**PLANING HULL** – A hull designed to lift, thereby reducing friction and increasing efficiency.

**PORPOISE** – A condition in which the bow bounces up and down caused by trimming the engine too far out.

**PORT** – (1) The left side of a boat when facing the bow. (2) A destination or harbor.

**PRIVILEGED BOAT** – Term used for the boat with the right-of-way.

**RIGHT-OF-WAY** – Term for the boat that has priority in meeting or crossing situations. The stand on or privileged boat.

**RULES OF THE ROAD** – Regulations for preventing collisions on the water.

**SPEEDOMETER PICKUP TUBE** – Also called pitot tube. The plastic device that extends below the bottom of the boat. It connects to the speedometer with plastic flexible tubing.

**STAND ON BOAT** – Term for the boat that must maintain course and speed in meeting or crossing situations. The privileged boat.

**STARBOARD** – The right side of the boat when looking toward the bow.

**STERN** – The back of the boat.

**STOW** – To pack the cargo.

**SURGE BRAKES** – A type of trailer braking system designed to automatically actuate when the tow vehicle's brakes are applied.

**TRANSDUCER** – The unit that sends/receives signals for the depth sounder.

**TRANSOM** – The transverse beam across the stern.

**TRIM** – Fore to aft and side to side balance of the boat when loaded.

**UNDERWAY** – Boat in motion, i.e., not moored or anchored.

**USCG** – United States Coast Guard.

**VISUAL DISTRESS SIGNAL** – A device used to signal the need for assistance such as flags, lights and flares.

**WAKE** – The waves that a boat leaves behind when moving through the water.

**WATERWAY** – A navigable body of water.

**WINDLASS** – An electric winch to raise the anchor.

# GENERAL INFORMATION

## SYMBOLS



Light

Filter

Sling Point

Compass

Anchor  
Lights

Blower

Boat

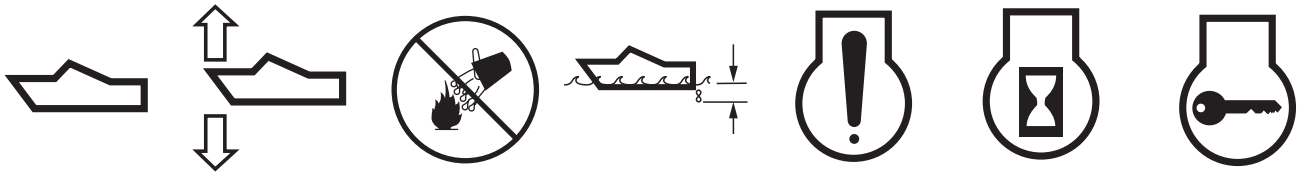

Boat  
Profile

Bow  
Trim

Do Not  
Use Water

Draft

Engine  
Caution

Engine  
Hour Meter

Engine  
Key

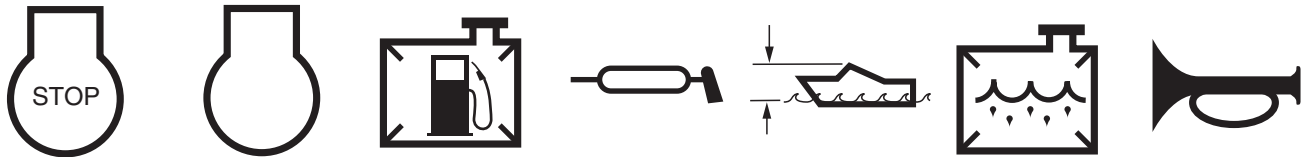

Engine  
Stop

Engine

Fuel  
Tank

Grease

Height  
Above Water

Holding  
Tank

Horn

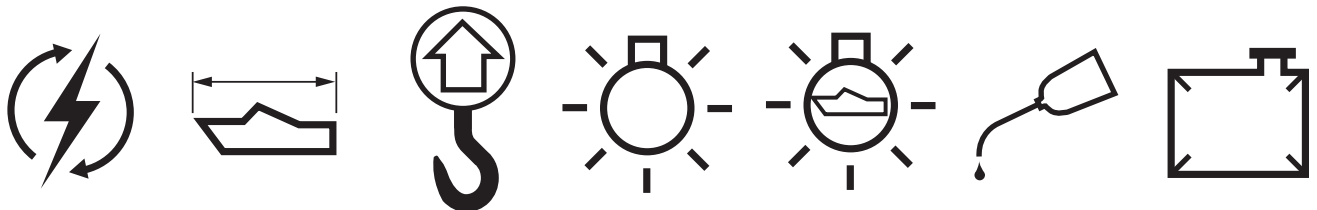

Ignition  
Switch

Overall  
Length

Lift  
Point

Light

Navigation  
Lights

Oil

Tank



Trim  
Tabs

Water  
Tank

Windshield  
Wipers

Safety Alert  
Symbol

COB\_0030\_A

## SPECIFICATIONS

	<b>R3</b>	<b>R3 Surf</b>	<b>R3WSS</b>
Length Overall w/Swim Platform	23' 10" (7.26 m)	23' 10" (7.26 m)	23' 10" (7.26 m)
Beam	8' 6" (2.59 m)	8' 6" (2.59 m)	8' 6" (2.59 m)
Interior Cockpit Width	95" (2.41 m)	95" (2.41 m)	95" (2.41 m)
Deadrise at Transom	21°	21°	21°
Fuel Capacity	50 gal (189 L)	50 gal (189 L)	50 gal (189 L)
Freshwater Capacity	10 gal (38 L)	10 gal (38 L)	10 gal (38 L)
Bridge Clearance w/o Bimini	62" (1.57 m)	62" (1.57 m)	62" (1.57 m)
Bridge Clearance w/Bimini	89" (2.26 m)	89" (2.26 m)	89" (2.26 m)
Bridge Clearance w/Arch or Tower	96" (2.44 m)	96" (2.44 m)	96" (2.44 m)
Draft Drive Up	21" (0.53 m)	34" (0.86 m)	21" (0.53 m)
Draft Drive Down	37" (0.94 m)	37" (0.94 m)	37" (0.94 m)
Dry Weight	4450 lbs (2018 kg)	4450 lbs (2018 kg)	4450 lbs (2018 kg)
Boat Certified Capacity	12 persons	12 persons	12 persons
Boat Certified Capacity w/gear	1800 lbs (816 kg)	1800 lbs (816 kg)	1800 lbs (816 kg)



# GENERAL INFORMATION

## LAYOUT

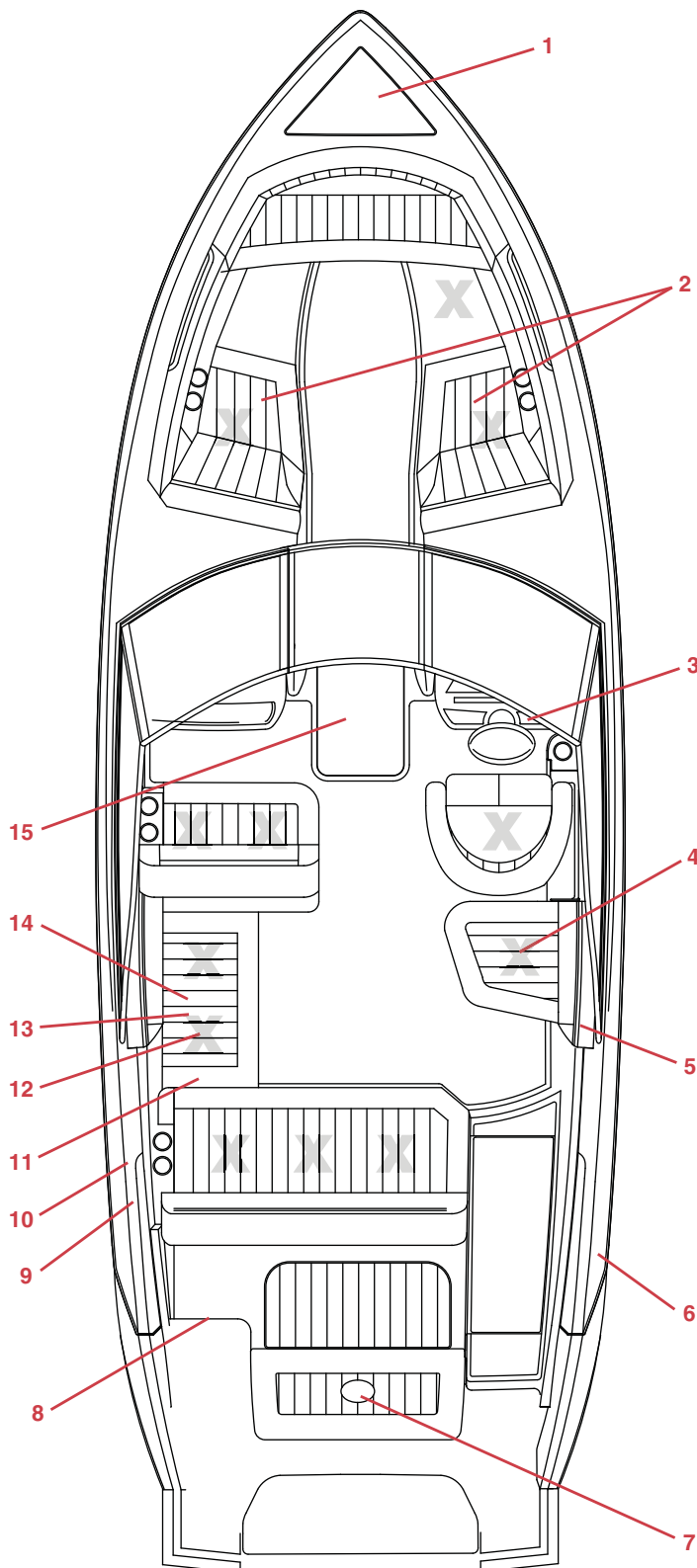

1. Anchor Locker
2. Bow Seat Storage
3. Ignition Safety Switch
4. Ice Chest
5. Motor Box Switch
6. Fuel Fill
7. Ski Tow Pylon Receptacle
8. Optional Transom Shower
9. Optional Water Fill
10. Anchor Light Receptacle
11. Battery Selector Switch
12. Optional Air Compressor/Storage
13. Fire Extinguisher Storage
14. Ski Tow Pylon Storage
15. Ski Locker/Bimini Top Hardware Storage

X  
12 Designated  
Occupant  
Positions

COB\_0363a\_A

## PROPELLER APPLICATION CHART

MFGR	ENGINE	DRIVE	PHP	STD RATIO	OPT RATIO	SS PROP	SS PART#	SS MFG PART#
MERC	4.5 L MPI	BRAVO 3	250	2.20		21 pitch 3 Blade	481227	842940L70
						21 pitch 4 Blade	481226	842939L70
MERC	6.2 L MPI	BRAVO 3	300			22.5 pitch 4 Blade	481238	8M8022400
						22.5 pitch 3 Blade	481239	8M8022410
MERC	6.2 L MPI	BRAVO 3	350			26 pitch 4 Blade	481230	8M8022440
						26 pitch 3 Blade	481231	8M8022450
MERC	8.2 MAG	BRAVO 3X	380	1.81		22.5 pitch 4 Blade	481238	8M8022400
						22.5 pitch 3 Blade	481239	8M8022410
MERC	8.2 MAG HO	BRAVO 3X	430	1.81		24 pitch 4 Blade	481228	8M8022420
						24 pitch 3 Blade	481229	8M8022430
VOLVO	V8-300-G5	DP	300	2.32		FH5's	481405	3851495
VOLVO	V9-300-G5	FWD	300	2.32		K5's	481593	22417008
VOLVO	V8-350-G5	DP	350	2.32		FH6's	481406	3885842
VOLVO	V8-350-G5	FWD	350	2.32		K4's	481592	22417007
VOLVO	V8-380	DP	380	2.32		FH6's	481406	3885842
VOLVO	V8-380	FWD	380	2.32		K5's	481593	22417008
VOLVO	V8-430	DP	430	2.14		FH6's	481406	3885842

# GENERAL INFORMATION

## ALPHABETICAL INDEX

Addendum A – Service Assist Service		
Agreement	1-3	
After Boating	7-2	
After Boating:	3-6	
After Fueling:	3-3	
Aids to Navigation	2-23	
Air Compressor - Optional	3-34	
Alphabetical Index	1-19	
Amenities	1-8	
Anchor Light	3-35	
Anchoring	3-17	
Approaching a Mooring	3-13	
Approaching a Slip	3-13	
Audible/Visual Distress Signals	2-12	
Automatic Charging Relay (ACR)	3-36	
Basic Maneuvering	3-13	
Battery Charger - Optional	3-36	
Battery Connections	4-6	
Battery Switch	3-35	
Before Each Use	6-2	
Before Launching	7-1	
Before Operating	1-7	
Before Starting Checklist	3-6	
Before You Start	3-1	
Bilge	2-5	
Bilge	5-10	
Black/White Electric or Folding Arch with Sunshade	3-40	
Boarding	3-5	
Boat in the Water	3-33	
Boat Information	7-6	
Boat on a Trailer	3-33	
Boat Theory	2-3	
Bow Tonneau Cover - Optional	3-37	
Break-In	6-2	
Burdened Boats	2-21	
Cabinetry and Wood	5-5	
Cabinetry	5-5	
California Air Resource Board (CARB) Label	2-6	
California Evaporative Emissions Control System Warranty Statement	1-4	
Canvas	5-9	
Capacity	2-14	
Captain's Chair Adjustments and Operation	3-32	
Carbon Monoxide Detectors, if equipped	3-8	
Care and Cleaning of Vinyl	5-1	
Carpet	5-5	
Casting Off	7-2	
Cedar	5-5	
Certificate of Limited Warranty	1-2	
Certifications	1-7	
Circuit Breaker Panel	4-5	
Cleaning Agents	2-7	
Cleaning Canvas	5-9	
Cleaning Deck and Hull	5-5	
Cleaning Stainless Steel	5-7	
Clear Vinyl "Isinglass"	5-10	
Cobalt Checklist	3-8	
Cockpit Dinette Table - Optional	3-34	
Cockpit Heater	6-6	
Cockpit Tonneau Cover - Optional	3-37	
Collisions/Leaks	2-9	
Compass	2-2	
Components, Maintenance and Repairs	2-8	
Construction Standards/Certifications	1-8	
Cooling System	2-5	
Corrosion Protection	5-7	
CorrosionX	5-7	
Craft Design Category	1-6	
Crossing Situation	2-22	
Cruise Control - Optional	3-35	
Dark Stowage Areas	5-1	
Deck and Hull Care	5-6	
Deck and Hull	5-5	
Discharge of Oil	2-18	
Discharge/Disposal of Waste	2-7	
Distress Signals	2-10	
Docking	3-12	
Drive Unit Trim	3-14	
Drowning	2-10	
Drugs/Alcohol	2-16	
During Operation	7-2	
During Operation:	3-6	
Eclipse Arch w/Bimini	3-39	
Education Opportunities	2-3	
Electric Eclipse Arch with Bimini	3-39	
Electrical System	4-4	
Electrical System	6-3	
Electrical Systems	2-4	
Electrical	6-9	
Emergency Considerations	2-8	
Emission Control Warranty Information	2-6	
Engine	6-7	
Engine/Propulsion/Cooling System	6-3	
Entertainment System	3-20	
Environmental Considerations	2-6	
Environmental Considerations	3-19	
EPA Fuel Tank	3-4	

Every 100 Hours . . . . .	6-3	INSHORE – Category C . . . . .	1-7
Every 50 Hours . . . . .	6-2	Inside the Bulkhead . . . . .	5-8
Excessive Noise . . . . .	2-18	Installation . . . . .	3-40
Excessive Noise . . . . .	2-7	Insurance . . . . .	2-3
Exhaust Emissions . . . . .	2-7	Intended Use . . . . .	1-6
Exhaust System . . . . .	2-5	Introduction. . . . .	1-6
Features/Construction . . . . .	1-8	Introduction. . . . .	4-1
Federal, State and Local Regulations . . . . .	2-18	Isolated Danger Markers . . . . .	2-27
Fire Extinguisher . . . . .	2-2	Lateral Markers . . . . .	2-25
Fire Suppression Equipment . . . . .	4-4	Launching Checklist . . . . .	3-5
Fire. . . . .	2-8	Launching. . . . .	3-5
Fire/Explosion . . . . .	3-1	Layout. . . . .	1-17
First-Time Operation . . . . .	3-1	Leather Care . . . . .	5-1
Fishery Resources. . . . .	2-7	Leaving. . . . .	3-11
Flip Down Swim Step. . . . .	3-33	Life Raft . . . . .	2-13
Float Plan. . . . .	7-5	Lifesaving Devices . . . . .	2-2
Flooding/Swamping . . . . .	2-9	Lifesaving Equipment. . . . .	2-11
Focused Refracted Light . . . . .	5-6	Lifting the Boat . . . . .	6-4
Folding the Sunshade and Arch . . . . .	3-40	Light Structures . . . . .	2-27
Foreign Species. . . . .	2-8	Lighthouses . . . . .	2-28
Freezing Temperatures . . . . .	3-19	Load Distribution . . . . .	3-14
Fresh Water - Optional . . . . .	3-36	Loading. . . . .	2-14
Fresh Water. . . . .	4-3	Loading. . . . .	3-5
Fresh Water. . . . .	6-4	Lowering. . . . .	3-18
Fuel Log. . . . .	7-4	Lubrication System. . . . .	2-5
Fuel Requirements . . . . .	3-2	Maintenance Schedule. . . . .	6-1
Fuel Routing . . . . .	4-2	Maintenance Techniques . . . . .	5-2
Fuel System. . . . .	2-3	Marine Growth . . . . .	5-10
Fuel System. . . . .	6-4	Marine Sanitation . . . . .	2-18
Fuel . . . . .	3-2	MARPOL Treaty. . . . .	2-6
Fuel/Spillage . . . . .	2-6	Material Note . . . . .	5-6
Fueling. . . . .	3-2	Medical Emergency . . . . .	2-10
Fuses. . . . .	4-6	Meeting Head-On. . . . .	2-22
Galvanic Corrosion . . . . .	5-8	MerCruiser . . . . .	1-8
General Cleaning. . . . .	5-6	Minor Lights . . . . .	2-27
General Maintenance Instructions . . . . .	5-2	Monthly. . . . .	6-3
General Safety. . . . .	2-14	Mooring Buoys . . . . .	2-24
Getting Underway . . . . .	3-6	Motor Box Assembly or Electric Motor Box Assembly . . . . .	3-43
Gray Water . . . . .	6-4	Nautical Terms. . . . .	1-12
Grounding . . . . .	2-9	Navigation . . . . .	2-21
Handholds . . . . .	2-14	Navigation Lights . . . . .	2-2
Handling Dock and Mooring Lines. . . . .	3-7	NMMA . . . . .	1-7
Helm and Instrumentation . . . . .	3-21	NOTES. . . . .	1-viii
Helm Seat Electric Slide Operation (Optional). . . . .	3-32	OCEAN – Category A. . . . .	1-6
Helm Seat With the Electric Slide Operation. . . . .	3-32	OFFSHORE – Category B . . . . .	1-7
High-Speed Operation. . . . .	3-16	On the Water . . . . .	3-5
Horn or Whistle . . . . .	2-2	Operating Conditions . . . . .	2-15
Ice Chest . . . . .	3-34	Operating in Shallow Water . . . . .	2-9
If You Sell Your Cobalt Boat . . . . .	1-7	Operation Checklist . . . . .	2-6

# GENERAL INFORMATION

Operation Failure . . . . .	2-10	Salt Water . . . . .	5-8
Operation Quick Reference . . . . .	7-1	Scheduled Maintenance and Service . . . . .	6-1
Other Areas . . . . .	5-8	Sea Anchors . . . . .	2-12
Other Canvas Components . . . . .	5-10	Sea Grass Floor Covering Cleaning Instructions . . . . .	5-2
Other Navigation Equipment . . . . .	2-2	Seating . . . . .	2-14
Overtaking . . . . .	2-23	Seaworthiness Inspection . . . . .	2-5
Owner Responsibility/Warranty Procedure . . . . .	1-7	Serial Number Locations . . . . .	1-8
Owner/Operator Responsibilities . . . . .	2-1	Service Log . . . . .	7-3
Paints . . . . .	2-7	Setting . . . . .	3-18
Passengers . . . . .	2-16	SHELTERED WATERS – Category D . . . . .	1-7
Periodic Comprehensive Cleaning . . . . .	5-3	Shifting/Running . . . . .	3-9
Personal Flotation Devices . . . . .	2-11	Shipshape . . . . .	3-5
Platform Dragging (“Teak Surfing”) . . . . .	2-20	Signal Words/Definitions . . . . .	2-13
Plumbing . . . . .	6-9	Ski Tow Eye/Pylon . . . . .	3-42
Precautions . . . . .	3-1	Skill/Experience . . . . .	2-16
Premium Bimini Top - Optional . . . . .	3-37	Snap Fasteners . . . . .	5-10
Premium Bimini Top with Easy Fold - Optional . . . . .	3-38	Solid Waste Disposal . . . . .	2-18
Pre-Operation . . . . .	7-1	Special Cleaning Problems . . . . .	5-9
Pre-Operation: . . . . .	3-6	Special Situations . . . . .	2-23
Preventive Steps . . . . .	5-7	Specifications . . . . .	1-16
Privileged Boats . . . . .	2-21	Spot and Stain Removal . . . . .	5-4
Propeller Application Chart . . . . .	1-18	SS Arch With Bimini Instructions - Optional . . . . .	3-41
Proposition 65 . . . . .	2-7	Stainless Steel and Chrome . . . . .	5-7
Propulsion System . . . . .	2-3	Standard and Optional Equipment . . . . .	3-28
Propulsion System . . . . .	3-6	Starting Engines . . . . .	7-2
Publications . . . . .	1-12	Starting the Engine . . . . .	3-8
Qualified Boat Operators . . . . .	2-18	Starting/Shifting/Steering/Stopping . . . . .	3-8
Quarterly . . . . .	6-3	Stationary Arch with Awlgrip Topcoat . . . . .	5-11
Radar Reflectors . . . . .	2-12	Steering System . . . . .	2-3
Radio Communication . . . . .	2-10	Steering . . . . .	3-9
Range Lights . . . . .	2-28	Stopping the Engine . . . . .	3-11
Reactivating the Boat After Storage . . . . .	6-6	Stopping the Engines . . . . .	7-2
Recommended Safety Equipment . . . . .	2-2	Storage Cradle . . . . .	6-5
Recommended Spare Parts . . . . .	2-3	Storage . . . . .	5-6
Registration/Documentation . . . . .	2-1	Storage/Winterization . . . . .	6-5
Regulatory Markers . . . . .	2-24	Storms . . . . .	2-9
Remote Control System . . . . .	2-3	Surf Pockets . . . . .	3-41
Removable Bow Seat Cushion - Optional . . . . .	3-34	Swim Platform Mat Care and Maintenance . . . . .	5-6
Removal . . . . .	3-40	Symbols . . . . .	1-15
Rendering Assistance . . . . .	2-19	Teak Swim Platform . . . . .	5-5
Reporting Accidents . . . . .	2-19	Techniques . . . . .	3-13
Required Safety Equipment . . . . .	2-2	Tie-Down Locations . . . . .	3-42
Returning to Port . . . . .	7-2	Tool Kit - Optional . . . . .	3-43
Returning . . . . .	3-11	Topside . . . . .	5-7
Rules of the Road/Sound Signals . . . . .	2-21	Towing . . . . .	3-18
Safety Alert From August 28, 2001: . . . . .	2-21	Transom Tilt Switch - Optional . . . . .	3-43
Safety While Boating . . . . .	2-18	Trim Tabs . . . . .	3-15
Safety . . . . .	2-13	Trim . . . . .	3-14
Salt Water . . . . .	3-19	Troubleshooting . . . . .	6-7

Types of Buoys . . . . .	2-23
Unscheduled Maintenance . . . . .	6-3
Using Lifting Slings . . . . .	6-4
Ventilation System . . . . .	2-4
Ventilation . . . . .	2-16
Vinyl Interior and Upholstery . . . . .	5-1
Visibility . . . . .	2-16
Visual Distress Signals . . . . .	2-2
Volvo Penta Ocean Series Outdrive . . . . .	3-34
Volvo Penta . . . . .	1-8
Wake/Wash . . . . .	2-19
Wake/Wash . . . . .	2-7
Warning Labels . . . . .	1-9
Warning Markers . . . . .	2-29
Warranty Service Requirements . . . . .	1-7
Warranty Transfer Form . . . . .	7-7
Water Rescue (Man Overboard) . . . . .	2-10
Water Sports Safety . . . . .	2-19
Water System (if equipped) . . . . .	6-4
Water System . . . . .	4-4
Water/Plumbing . . . . .	4-3
Weather/Seas . . . . .	2-15
Weighing (May require two persons) . . . . .	3-18
Welcome . . . . .	1-1
When Fueling: . . . . .	3-3
Whistle/Horn Signals . . . . .	2-21
Windshield Latch . . . . .	3-34
Windshield . . . . .	5-10
Woodgrain Dash . . . . .	5-5
Your Warranty Rights and Obligations . . . . .	1-4
Zippers . . . . .	5-10



# RESPONSIBILITIES AND SAFETY

Your safety, the safety of your passengers, and other boaters are among your responsibilities as operator of this boat. Your boat must be in compliance with U.S. Coast Guard (USCG) safety equipment regulations. You should know how to react correctly to adverse weather conditions, have good navigation skills and follow the “Rules of the Road” as defined by the USCG and state/county/local regulations.

## OWNER/OPERATOR RESPONSIBILITIES

At the time of delivery, the owner/operator is responsible for:

- Understanding warranty terms and conditions of both the propulsion unit(s) and boat.
- Obtaining insurance.
- Examining boat to ensure proper operation of all systems.

Before operating the boat, the owner/operator is responsible for:

- Obtaining state registration of the boat.
- Providing the proper USCG required safety equipment.
- Following proper break-in procedure for the propulsion units.
- Understanding safety information and proper operating procedures within this manual.

While operating the boat, the owner/operator is responsible for:

- Knowing that all safety equipment and personal flotation devices are in good condition and suitable for your boat and passenger load.
- Having at least one other passenger who is capable of handling the boat in an emergency.
- Following safe operating practices and the rules of the road.
- Understanding proper maintenance and knowledge of the boat’s operating systems.
- Providing safety training for the passengers.
- Avoiding use of alcohol and other drugs.
- Providing assistance to other boaters.

## Registration/Documentation

The USCG requires that all power boats operated on the navigable waters of the U.S. must be registered in the state of main use; also, many states require registration in that state whenever boating on waters within their state boundary. Contact your state boating authorities (and neighboring states) for registration information on boats and trailers.

Your authorized Cobalt dealer can supply you with the appropriate forms.

## Required Safety Equipment

The Federal Boat Safety Act of 1971 (FBSA/71) established minimum safety standards for boats and associated equipment, specified by the USCG. In addition, the ABYC and the NMMA work with boat builders to develop voluntary standards that exceed base requirements.

The included safety equipment on your Cobalt boat meets or exceeds the standards of the USCG, ABYC and the NMMA. Some required safety equipment such as personal flotation devices are not included with your Cobalt boat. Your authorized Cobalt dealer can help you choose the appropriate equipment.



**NOTICE: Many states' equipment requirements go beyond USCG requirements. Contact your state boating office for further information. Equipment requirements for coastal and inland waters differ. Check with local authorities or the USCG for further information about coastal water requirements.**

## Navigation Lights

All power boats underway between sunset and sunrise must display proper navigation lights. All boats at anchor must display a proper anchor light. Anchor light must be visible 360 degrees. Your Cobalt boat is equipped with navigation lights to meet Inland Rules and may meet International Rules.

## Horn or Whistle

All boats over 16 ft (4.8 m) in length must be equipped with an operable horn or whistle, audible from one mile. Your Cobalt boat is equipped with a USCG approved horn.

## Compass

To aid in navigation, your Cobalt boat may have a compass mounted at the helm. Refer to the compass user's manual in your owner's packet for operating information. The compass may require calibration. Contact your authorized Cobalt dealer for more information.

## Other Navigation Equipment

Other navigation equipment, such as depth sounder, radar, LORAN system or global positioning system, can be installed by your authorized Cobalt dealer. Operation and maintenance of that equipment is provided by the manufacturer.

## Fire Extinguisher

All inboard/outboard boats must carry an appropriate portable marine type fire extinguisher in operable condition and accessible location. Your Cobalt boat is equipped with a portable fire extinguisher and may have a fixed system fire extinguisher.

## Lifesaving Devices

All boats must carry one USCG approved Type I, II or III, wearable, personal flotation device, of the proper size, for each person onboard. All boats over 16 ft (4.8 m) in length must carry one USCG approved Type IV throwable lifesaving device, such as a ring buoy or buoyant cushion. To meet requirements, each lifesaving device must have a currently legible USCG approval stamp permanently affixed. Your authorized Cobalt dealer can help you select appropriate PFDs and throwable lifesaving devices for your area.

## Visual Distress Signals

All boats over 16 ft (4.8 m) must have onboard day and night visual distress signals. Your authorized Cobalt dealer can help you select appropriate visual distress signals for your area.

## Recommended Safety Equipment

In spite of all efforts to the contrary, problems or mishaps sometimes occur while boating. Stock these items listed below on your boat to help make unexpected events more manageable.

- Anchor and anchor line
- Compass
- First aid kit
- Distress signals (flag for daytime, flares for darkness)
- Flashlight and spare batteries
- Portable radio



# RESPONSIBILITIES AND SAFETY

- Cellular phone
- Sea anchor
- Binoculars
- Emergency Position Indicating Radio Beacon (EPIRB)
- Boat hook
- Sun glasses and sun block lotion

## Recommended Spare Parts

The following list contains common spare parts you should carry onboard. Review all the equipment on your boat. Be sure to have spare parts available to maintain and make minor repairs if necessary. Refer to all operator's manuals in your owner's packet for the manufacturer's recommended spare parts.

- Lanyard for ignition safety switch
- Engine and generator oil
- Hydraulic fluid for the steering system and trim system
- Ignition keys
- Tape, tie straps and rope
- Light bulbs and fuses
- Propeller with attaching hardware

## Education Opportunities

Be boat smart from the start, take a boating safety course and get a free vessel safety check annually for your boat. For more information, contact: United States Coast Guard Auxiliary, [www.cgaux.org](http://www.cgaux.org); United States Power Squadrons, 888-FOR-USPS, [www.usps.org](http://www.usps.org). Most boaters can enhance their enjoyment of boating experiences through increased knowledge of safe operation, navigation and regulation of pleasure boats. The following is a list of some other agencies and organizations that offer Water Safety, First Aid and CPR courses or information.

Use the following resources for safety and other information not covered in this manual:

- U.S. Coast Guard - [www.uscgboating.org](http://www.uscgboating.org)
- Canadian Coast Guard - [www.ccg-gcc.gc.ca](http://www.ccg-gcc.gc.ca)
- American Red Cross - [www.redcross.org](http://www.redcross.org)
- U.S. Power Squadrons - [www.usps.org](http://www.usps.org)

- U.S. Coast Guard Auxiliary - [nws.cgaux.org](http://nws.cgaux.org)

Contact state and local boating offices to find boating safety courses in your area. In Canada, consult Canadian Power and Sail Squadrons.

## Insurance

You must get insurance before operating your new boat. Insurance for loss by fire, theft or other causes, or liability protection against accidents is a must for responsible boaters. The boat owner is legally responsible for any damage or injury caused when he, or someone else operating the boat, is involved in an accident. Many states have laws detailing minimum insurance needs. Your insurance agent or your dealer may be able to supply you with more information.

## BOAT THEORY

The following information briefly explains main system theory.

### Propulsion System

A propulsion system consists of an engine turning a shaft that transfers power to a propeller. Mounting may be outboards or stern drive (inboard engine/outboard propeller).

### Remote Control System

The shift levers and throttle levers are connected to the engine and propulsion units by mechanical push/pull cables. The shift lever controls the direction of the boat, and the throttle lever controls the speed of the boat.

### Steering System

The steering wheel (helm) is connected to a hydraulic cylinder. As you turn the helm, hydraulic fluid directs movement of a steering cylinder. The cylinder is mechanically connected to the drive units.

### Fuel System

The fuel system consists of a permanent tank with an air vent system, fuel level sensor and fuel fill components. The tank has an anti-siphon valve to prevent fuel from accumulating in the bilge if a hose should break.

### Ventilation System

The ventilation system removes fuel fumes using blowers from the engine compartment and takes in fresh air through vents. Always keep vents free from obstruction.

#### DANGER

**Avoid death, injury, fire or explosion. Operate the blower for at least four minutes each time you start the engine. In addition, the blower should be operated continuously when the boat is stopped, operating at cruising speed or when the generator is running.**

Store flammables only in approved, vented containers securely fastened in a locker sealed from the interior of the boat and vented out of the side of the boat. Storing flammables in areas not designed for vapor removal creates a hazard.

Be aware of carbon monoxide from your own or other boats. Allow air movement to dissipate fumes.

### Electrical Systems

#### DANGER

**Never use an open flame in the battery storage area. The battery will explode if a flame or spark ignites the free hydrogen gas given off during charging. Be sure to prevent sparks near the battery.**

#### WARNING

**Only a qualified marine electrical technician may service the boat's electrical system.**

- **Disconnect the electrical system from its power source before performing maintenance. Never work on the electrical system when it is energized.**
- **Electrical appliances must not exceed the rated amperage of the boat circuit.**
- **Observe the electrical system carefully while it is energized. The only electrical components that can be left unattended are the automatic bilge pump, fire protection and alarm circuits.**

#### CAUTION

**Always turn off the engine before servicing the battery. Disconnect the battery cables before working on the electrical system to prevent arcing or damage to the engine's alternator. Disconnect the negative (-) cable first, and then disconnect the positive (+) cable.**

Your Cobalt boat can be equipped with one or two electrical systems. A direct current (DC) system is battery powered and supplies electricity to lights, pumps, blowers, engine ignition and sometimes a refrigerator. An alternating current (AC) system is shore power, or generator, and supplies electricity to the electrical outlet, air conditioning, battery charger and other 110V AC or 220V AC appliances or components. Do not exceed rated amperage of electrical circuits.

If your boat is equipped with an optional battery charger, it must only be plugged into a Ground Fault Circuit Interrupter (GFCI) protected AC outlet. When using an extension cord, connect the charger AC plug first before connecting the extension cord to the GFCI outlet.

# RESPONSIBILITIES AND SAFETY

Make the connection in an open area, free of any explosive fumes. The connections must be secure to avoid contact with any water.

## Cooling System

The engines and generator, if equipped, are cooled by the continuous intake of raw water through independent water intakes. The water flows to water pumps on the engines and/or generator for circulation around internal components. The engine water intakes and outlets are located in the drive units. A generator water intake is in the bottom of the hull and the exhaust is usually on the side of the boat, above the waterline. If your boat is equipped with an air conditioner, the air conditioner water intake is in the bottom of the hull and exits from the side. Your Cobalt boat may be equipped with a self-contained cooling system that pumps a mixture of fresh water and antifreeze through a large heat exchanger to reduce temperatures. Raw water is circulated through the other side of the heat exchanger to dissipate heat absorbed by the coolant mixture.

## Exhaust System

The engine and generator exhaust systems, if equipped, remove the gases produced by the running engine and vents them away from the boat. Engine exhaust is usually vented through the drive unit propeller but may be diverted through the transom with the optional captain's call exhaust system. Engine and generator cooling water are also removed along with the exhaust gases.

Never change the original exhaust system configuration. Inspect the entire exhaust system for tightness before each use. Leaks permit carbon monoxide exposure. Some boating areas require the use of a muffler to reduce exhaust sound levels. Consult your authorized Cobalt dealer for information.

## Lubrication System

The engines and generator, if equipped, use a pressurized continuous loop lubrication system that must be periodically serviced in accordance with the manufacturer's recommendations. The engines have electrical transducer units to provide oil pressure signals to gauges at the helm. Full oil pressure must be available for proper lubrication, so monitoring the gauges is important, especially when operating at cruising speeds and above.

## Bilge

A drain plug is located in the transom to allow water to drain before trailering and storing. Before every use, inspect the drain plug and bilge pump. Routinely clean pump strainer, float switch, intake and area under the pump. It is a violation of federal law to pump overboard bilge that contains oil or fuel.

### **WARNING**

**Always install the drain plug before launching to prevent the boat from sinking.**

## Seaworthiness Inspection

The following checks are essential to safe boating and must be performed before starting the engines. Get into the habit of performing these checks in the same order each time so that it becomes routine.

- Check the weather report, wind and water conditions.
- Check that required safety equipment is onboard.
- Check that fire extinguisher(s) is fully charged.
- Check that bilge drain plug is properly installed.
- Check that no fuel, oil or water is leaking or has leaked into the bilge compartment.
- Check all hoses and connections for leakage and damage.
- Check that all batteries are fully charged and have the proper level.
- Check electrical circuits (lights, pumps, horn, etc.) for proper operation.

- Check that steering system operates properly.
- Be sure the boat is not overloaded.
- Check that all maintenance has been performed.

### Operation Checklist

While operating your boat, frequently check that the control and steering systems continue to operate smoothly. Monitor your gauges for signs of abnormal behavior. Beware of any excessive vibration. Refer to *Section 3, Before Starting Checklist*.

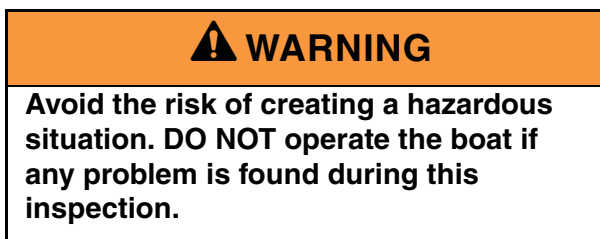

Problems found during this inspection should be handled by your authorized Cobalt dealer.

### Environmental Considerations

As a boater, you already appreciate nature's beauty and the peace of the great outdoors. It is a boater's responsibility to protect the natural environment by keeping waterways clean.

### MARPOL Treaty

The USCG enforces the International Convention for the Prevention of Pollution from ships, commonly referred to as the MARPOL Treaty (MARine POLLution). This treaty prohibits the overboard dumping of all ship-generated plastics, chemicals, garbage and oil.

### Fuel/Spillage

The spilling of fuel or oil into our waterways contaminates the environment and is dangerous to wildlife. Do not discharge or dispose of fuel or oil into the water; it is prohibited and you can be fined. These are two common, accidental types of discharge:

- Overfilling the fuel tanks
- Pumping contaminated bilge water

### California Air Resource Board (CARB) Label

Your boat may have an environmental star label affixed on the bow, port side of the boat as part of the California Air Resource Board (CARB) SD/I rule. This label must stay affixed to the boat if it is operated in California. The label identifies your boat is equipped with a California Certified Engine. The label is positioned so it will be at the leading or trailing edge of the state registration numbers.

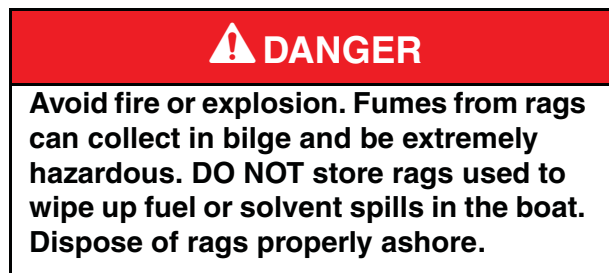

### Emission Control Warranty Information



COB\_0016\_A

The engine in your Cobalt boat meets the strict requirements set forth by CARB. The engine has a special environmental tag and the boat has this label affixed to it. The tag and the label are required by CARB. The label has 1, 2, 3 or 4 stars. The label **MUST** be affixed to the boat, if the boat is operated in the state of California and/or bordering waters.

Refer to *Section 1, California Evaporative Emissions Control System Warranty Statement* for information about your rights and obligations and for components covered under this warranty.

# RESPONSIBILITIES AND SAFETY

## Proposition 65

 **WARNING**

**A wide variety of components used on this vessel contain or emit chemicals known to the state of California to cause cancer, birth defects and other reproductive harm.**

**EXAMPLES INCLUDE:**

- **Engine and generator exhaust**
- **Engine and generator fuel, and other liquids such as coolants and oil, especially used motor oil**
- **Cooking fuels**
- **Cleaners, paints and substances used for vessel repair**
- **Waste materials that result from wear of vessel components**
- **Lead from battery terminals and from other sources such as ballast or fishing sinkers**

**TO AVOID HARM:**

- **Keep away from engine, generator and cooking fuel exhaust fumes.**
- **Wash areas thoroughly with soap and water after handling the substances above.**

## Discharge/Disposal of Waste

Waste means all forms of garbage, plastics, recyclables, food, wood, detergents, sewage and even fish parts in certain waters - in short, nearly everything. We recommend you bring back everything you take out with you for proper disposal ashore. Use an approved pump-out facility at your marina. Many areas prohibit the discharge of sewage overboard or even an operable overboard waste discharge.

## Excessive Noise

Noise means engine noise, radio noise or even voices. Many bodies of water have adopted noise limits. Do not use thru-transom exhaust unless you are well offshore. Music and loud conversation can carry a considerable distance on water, especially at night.

## Wake/Wash

Be alert for NO WAKE zones. You may be responsible for any damage or injury caused by your wake/wash. Prior to entering a no wake zone, come off plane to the slowest steerable speed.

## Exhaust Emissions

Increased exhaust (hydrocarbon) emissions pollute our water and air. Keep your engine tuned and boat hull clean for peak performance. Consult your authorized Cobalt dealer and propulsion unit operator's manual for information.

## Paints

If your boat is kept in water where marine growth is a problem, the use of anti-fouling paint may reduce the growth rate. Be aware of environmental regulations that may govern your paint choice. Contact your local boating authorities for information.

## Cleaning Agents

Household cleaners should be used sparingly and not discharged into waterways. Do not mix cleaners and be sure to use plenty of ventilation in enclosed areas. DO NOT use products which contain phosphates, chlorine, solvents, nonbiodegradable or petroleum based products. Citrus-based cleaners are excellent for marine cleaning purposes and are safe for you and the environment. Do not use citrus-based cleaners on stainless steel.

## Fishery Resources

There is a tremendous drain on our fishery resources. Over-fishing and pollution have strained the fish population. Do your part by keeping only what you will eat and practice catch-and-release.

### Foreign Species

If you trailer your Cobalt boat from lake to lake, you may unknowingly introduce a foreign aquatic species from one lake to the next. Thoroughly clean the boat below the waterline, remove all weeds and algae, and drain the bilge before launching the boat in a new body of water.

### Components, Maintenance and Repairs

Only your authorized Cobalt dealer should make any alterations, modifications or repairs that could affect safety, design integrity or warranty coverage. Included with your owner's packet are your propulsion unit manuals. These manuals were prepared by the manufacturer and contain information concerning the operation and care of your engine and drive unit. Please read these manuals thoroughly and become acquainted with this information.

It is advisable to maintain a service log to record service checks, such as oil changes, so you can determine when it is time for servicing. A maintenance log is helpful when requesting warranty service using the extended warranty coverage. Be sure to collect receipts for work performed and make an entry in the Service Log in the back of this manual.

### Emergency Considerations

Be prepared to deal with emergencies before they happen. Try to formulate a plan for each type in advance so that decisions can be made quickly and without hesitation. Precious moments lost can mean the difference between losing and saving a life.

### Fire

You must be prepared and act quickly when dealing with a fire. It is not recommended to battle a fire for an extended period of time. Turn engines off and abandon the boat if the fire cannot be extinguished quickly. Swim at least 25 yards (23 meters) upwind from the boat and use the visual distress signals to get assistance. Onboard fires involving the fuel system usually result in either an explosion that completely destroys the boat, or the boat burning to the waterline and self-extinguishing. Deciding on abandoning the boat or staying to fight the fire is difficult and depends on many factors. Try to formulate a fire plan in advance to make that decision quickly and without hesitation.

The USCG and other law enforcement agency requirements for fire extinguishers are only the minimum needed. Your Cobalt boat is equipped with at least one portable fire extinguisher and may have fixed fire extinguishers in the generator compartment and in the engine compartment (fixed fire extinguishers are normally an option on most Cobalt boats). If you are in question of whether your boat is equipped with fixed fire extinguishers, contact your authorized Cobalt dealer. For the location of your fire extinguisher, refer to *Section 1, Layout*. Remember, install extra extinguishers where they might be needed. Inspect extinguishers on a regular basis.

#### **WARNING**

**Avoid injury or death. Gasoline will float on top of water and can burn. If the boat is abandoned, swim upwind, far enough to avoid fuel that may spread over the surface of the water.**

# RESPONSIBILITIES AND SAFETY

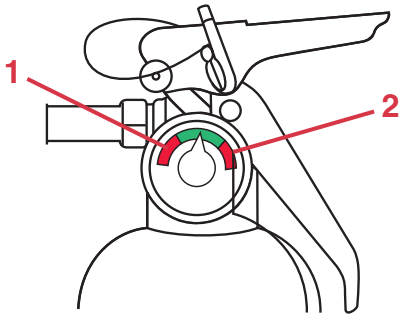

KC-0083C

- 1 – Recharge
- 2 – Overcharge

Be sure to:

- Use caution and do not smoke when refueling.
- Verify that fuel does not leak.
- Use only marine approved equipment on your boat.

## Flooding/Swamping

Improper loading, handling, water conditions, weather and anchoring are the most common causes of flooding. Insist on a safe, stable load. Do not operate the boat exceeding your ability to maneuver it. Use extreme caution in hazardous weather and rough water conditions. Anchor from the bow when using one anchor.

## Collisions/Leaks

If a collision occurs, immediately account for all passengers. Assess the hull for damage and activate the bilge pumps to reduce any water intake. Try to operate the boat to keep the damaged area above water. If necessary, call or signal for assistance. If a leak is discovered, immediately determine the cause. A collision with an underwater object could cause the hull to develop a leak. A loose fitting or hose clamp on a piece of equipment could cause a leak. Try to repair the leak if possible. If a leak is threatening the safety of you and your passengers, call or signal for assistance.

## Operating in Shallow Water

### **⚠ WARNING**

**COLLISION HAZARD – Use extra caution in shallow water or where underwater/floating objects may be present. Hitting an object at high speed or severe angle can seriously injure people and damage your boat.**

- Shallow water presents obvious hazards including insufficient water depth, sand bars, stumps, or other unmarked obstructions.
- Other hazards in shallow water include mud, sand, weeds, rocks, logs and debris. These hazards can damage your boat hull or underwater gear and can foul your engine cooling water intakes, which could cause overheating.
- Know the area in which you are operating. Consult charts and ask local boaters. If you know or suspect shallow water, post a lookout and proceed slowly.
- When beaching, be aware how tide can affect the boat. Never leave a beached boat unattended or unanchored.

## Grounding

In the event you run aground, assess the situation before proceeding. Immediately stop any water from entering the boat. Inspect the propulsion unit(s), steering and control systems, and the hull for damage. Maneuver the boat to safe water only if the hull and all operating systems are in satisfactory operating condition. Otherwise, call or signal for assistance.

## Storms

Take common sense precautions if you are forced to operate your boat in stormy conditions.

- Wear personal flotation devices (PFDs).
- Stow gear below deck and batten down equipment on deck.
- Reduce speed and head for a safe place that you can easily reach.

- If you lose power, keep the boat headed into the waves by using the anchor.

### Water Rescue (Man Overboard)

Immediately react to a person that has fallen overboard. Keep the victim constantly in your sight. Safely return to the victim as soon as possible. Throw the person a PFD. Turn the engines off and help the person into the boat.

### Medical Emergency

Be prepared in the event of an emergency. Know how to use your first aid kit. Be aware of any special medical conditions of your passengers.

### Drowning

React to a drowning victim the same as described in Water Rescue. Handle victims with care; they could be injured. If necessary, resuscitate the victim. Immediately signal for help and keep the victim warm.

### Operation Failure

Have equipment available and be prepared to rig an emergency steering system in case of an emergency with the drive units.

If you experience a propulsion, steering or control failure, immediately turn off the engines. Release the anchor to prevent drifting. Try to determine the failure and repair, if possible. Otherwise, call or signal for assistance.

### Distress Signals

Federal law also requires boats 16 ft (4.8 m) and longer to carry day and night visual distress signals when operating on coastal waters, the Great Lakes, territorial seas or those waters directly connected to them, up to a point where the body of water is less than two miles wide. Carry several types of signaling devices to handle a variety of conditions. Have enough signals onboard to last three days.



**NOTICE: Some pyrotechnics are restricted from use on certain bodies of water, so check with local authorities.**

### Radio Communication

Radio communication is the most important avenue of receiving and sending information. Use a VHF/FM radio for short-range communication, and a single-sideband radio (SSB) for long-range. For all U.S. waters, the National Weather Service operates the NOAA Weather Radio (NWR). This service provides continuous weather information on the following VHF/FM frequencies:

- 162.400 MHz • 162.500 MHz
- 162.425 MHz • 162.525 MHz
- 162.450 MHz • 162.550 MHz
- 162.475 MHz

### Coast Guard Marine Information Stations

- 2670.0 kHz • 8765.4 kHz
- 4428.7 kHz • 13113.2 kHz
- 6506.4 kHz

It is good practice to periodically monitor the weather.

VHF-FM Channel 16 and SSB 2182 kHz are designated for emergency use. Such situations can be categorized as:

- **Emergency** –  
“**MAYDAY, MAYDAY, MAYDAY**” – Used when a life or vessel is in imminent danger.
- **Urgency** –  
“**PAN-PAN, PAN-PAN, PAN-PAN**” (pronounced PAHN-PAHN) – Used when a person or vessel is in some jeopardy less than indicated by a Mayday call.
- **Safety** –  
“**SECURITY, SECURITY, SECURITY**” (pronounced SAY-CURE-IT-TAY) – Used for navigational safety or weather warning.

An emergency situation will be hectic and there will not be time to learn proper radio procedure.

**LEARN WHAT TO DO BEFORE YOU NEED TO DO IT.**



# RESPONSIBILITIES AND SAFETY

If you hear a distress call, stop all radio transmissions. If you can directly assist, respond on the emergency frequency. If you cannot assist, do not transmit on that frequency. However, continue to monitor until it is obvious that help is being provided.

Note that some areas may require a license to operate radiotelephone equipment. Consult your authorized Cobalt dealer for information.

## Lifesaving Equipment

The following equipment may or may not be required by federal/local regulations.

### Personal Flotation Devices

Federal law requires at least one Type I, II, III or V Personal Flotation Device (PFD) for each person onboard or being towed, and at least one Type IV throwable PFD in the boat.

There are four types of PFDs to wear and one type used for throwing in emergency situations.

**Type I Life Preserver:** Most buoyant PFDs are effective on all waters, especially open, rough water.



TYPE I  
LIFE PRESERVERS

KC-0041C

**Type II Buoyant Vest:** Good for calm water near shore on most inland waters where quick rescue is likely.



TYPE II  
BUOYANT VESTS

KC-0051C

**Type III Flotation Aid:** Good for most inland water applications where quick rescue is likely. Comes in various styles and some are designed for water sport activities.



TYPE III  
FLOTATION AIDS

KC-0042C

**Type IV Throwable Device:** Intended for heavy traffic inland waters where help is available. Designed to be thrown to a person in the water and should never be worn.



TYPE IV  
THROWABLE DEVICES

KC-0071C

**Type V Hybrid PFD:** Inflatable design for special use activities and may be used instead of a Type I, II, or III PFD if used in accordance with the approval conditions on the label and if worn when the boat is underway. Some Type V PFDs provide increased protection against hypothermia.



TYPE V HYBRID PFD  
MUST BE WORN  
WHEN UNDERWAY

KC-0043C



### NOTICE:

- A Type V PFD must be worn to be counted toward the minimum carriage requirements.
- Special PFDs are available for skiing and other water sports. These PFDs are constructed with materials suitable for high impact falls.

PFDs are intended to help save lives. The operator should set an example by wearing a PFD whenever boating. It is especially important that children and non-swimmers wear a PFD at all times.

Make certain all passengers know how to put on and properly adjust their PFDs. Also, selecting the proper type PFD for your kind of outing helps ensure your time on the water can be the safest possible. At the beginning of each season, check PFDs for damage and test for proper flotation. Refer to the PFD manufacturer's information.

### Audible/Visual Distress Signals







A distress call is transmitted on VHF/FM radio channel 16 (156.800 MHz) or 2182 kHz (SSB). Know your audible signals:

- For emergency, the call sign is "Mayday."
- For an urgent situation, the call sign is "Pan-Pan."

- For navigational safety and weather warnings, the call sign is "Security."

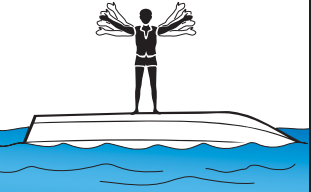
Repeat the call sign three times. Immediately react to a distress call. Assist, if possible, using an emergency frequency. Otherwise, continue to monitor the situation until help has arrived.

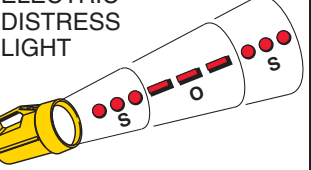
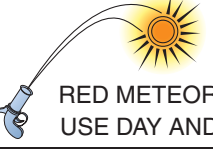
### VISUAL DISTRESS SIGNALS

 USE DAY ONLY	RED DISTRESS FLARE (HAND)  USE DAY AND NIGHT
 ARMS SIGNALS (USE BRIGHT CLOTH) USE DAY ONLY	USE DAY ONLY  SIGNAL (HAND)
ELECTRIC DISTRESS LIGHT  USE NIGHT ONLY	RED METEOR FLARE USE DAY AND NIGHT 
DYE MARKER USE DAY ONLY 	

COB\_0031\_A

If you are required to carry distress signals, you must have three USCG-approved pyrotechnic devices. Be sure they are in serviceable condition, not exceeding the expiration date and stored in a cool, dry location in a waterproof container.

### Sea Anchors

You should have a separate sea anchor onboard to slow drifting. In heavy seas, a sea anchor is set from the bow to control the boat's behavior. The sea anchor holds the bow to the sea and a slow drift.

### Radar Reflectors

Radar reflectors allow you to be seen by other vessels' radar within your area. Mount the reflector as high as possible on the radar arch.

# RESPONSIBILITIES AND SAFETY

## Life Raft

If operating offshore, you should consider carrying an inflatable life raft. A USCG-approved life raft meets a number of stringent specifications. The life raft must be large enough to hold all the boat's occupants and have its own equipment pack including a paddle.

A life raft can be stored in the aft storage area or in any other accommodating place on your boat.

## SAFETY

The popularity of boating and other water sports has undergone an immense growth over the past few years. Because of this, safety is an important issue for everyone who shares in the use of our waterways. Be smart when boating and using your equipment.

In emergency situations, it may be necessary to resort to measures which are not commonly practiced. Always assess the dangers of being in harm's way versus the protection of equipment. Keep a sound mind during an emergency and always think safety.

- Know the conditions of your boat and the environment.
- Have a float plan and inform others when you will return.
- Secure or store loose items before getting underway.
- Avoid sudden maneuvers at high speed and reduce speed in waves.

### **WARNING**

**Avoid fire, explosion, injury or property damage from improperly handled pyrotechnic signaling devices. Follow the manufacturer's directions.**

## Signal Words/Definitions

Throughout this manual specific precautions and symbols identify safety related information.

The Safety Alert Symbol means ATTENTION! BECOME ALERT! YOUR SAFETY IS INVOLVED!

### **DANGER**

**Indicates a hazardous situation which, if not avoided, will result in death or serious injury.**

### **WARNING**

Indicates a hazardous situation which, if not avoided, could result in death or serious injury.

### **CAUTION**

Indicates a hazardous situation which, if not avoided, may result in minor or moderate injury.



**NOTICE:** Indicates a property damage message.

The precautions listed in this manual and on your Cobalt boat are not all-inclusive. If a procedure, method, tool or part is not specifically recommended, you must satisfy yourself that it is safe for you and others, and that the boat will not be damaged or made unsafe as a result of your decision. **REMEMBER - USE COMMON SENSE WHEN OPERATING YOUR BOAT!**

### **General Safety**

Before each outing you should check all safety equipment, such as fire extinguishers, PFDs, flares, distress flags, flashlights and engine stop switches. They should be operable, in good condition, readily visible and easily accessed.

Check local weather reports before casting off; do not leave the dock area when strong winds and electrical storms are in the area or predicted to be in the area.

Tell someone your travel plans and leave them a float plan. A float plan makes the job of search and rescue much easier for authorities. A float plan template can be found in the back of this manual.

### **Seating**

Keep your passengers seated in seats. The boat's bow, gunwale, transom platform and seat backs are not intended for use as seats while underway.

### **Handholds**

### **WARNING**

**Avoid injury or death.**

- **Passengers should use handholds whenever the boat is underway.**
- **DO NOT allow passengers to sit on or in the stern sun lounges when the boat is underway.**
- **Read and understand this manual and the propulsion unit manual, and be sure that you understand all controls and operating instructions before attempting to operate the boat.**
- **Be in control of your boat. DO NOT operate your boat under the influence of alcohol or other drugs.**

Handholds are provided for your passengers' safety. Be sure your passengers use the handholds whenever the boat is underway. Failure to use handholds could result in a man overboard situation or personal injury.

### **Capacity**

Know the weight capacity of your boat. Do not overload your boat. Overloading of passengers, personal equipment and supplies could result in an accident, especially in rough waters.

### **Loading**

Be sure that passengers, personal equipment and supplies are in their proper location before operating the boat. This does not necessarily mean you can carry a passenger for every seat. Keep personal equipment and supplies to an "as needed" basis. Maintain a balanced load (front to back and side to side) at all times.

# RESPONSIBILITIES AND SAFETY

## Operating Conditions

Every waterway poses hazards that you should avoid, such as shallow water, tree stumps and sand bars. Ask local boaters for information and consult a marine chart when boating on unfamiliar waters. As the operator of the boat, you should try to avoid all hazards, known and unknown. The following information does not contain all possible water hazards. Operating in shallow water presents a number of hazards. Mud, sand, weeds and debris can foul a propulsion unit propeller or its cooling water. If a propulsion unit strikes an underwater object, check the propulsion unit and boat for damage. If a propulsion unit vibrates after striking an object, it may indicate a damaged propeller.

Sand bars in narrow inlets are constantly shifting, making it difficult to mark them with buoys. Tides in coastal areas affect water levels, producing sand bars. Sometimes sand bars are indicated by waves as they form into breakers when passing over the sand bar. Refer to **Grounding**, in this section, if you run aground on a sand bar. The water level around a dam spillway is a hazardous area. It is subject to rapid changes caused by currents and turbulence. Keep clear of the spillway areas below dams.







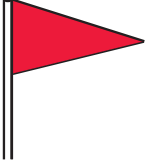

## Weather/Seas

Getting caught in severe weather is hazardous. It is recommended to check the weather, sea and wind conditions not only before you boat, but also periodically while you are boating. Refer to **Radio Communications**, in this section, for weather channel information. A change in wave height, wind direction and speed indicates deteriorating weather. Take common sense precautions if you are forced to operate your boat in stormy conditions:

- Wear PFDs.
- Stow gear below deck and batten down equipment on deck.
- Reduce speed and head for a safe place that you can easily reach.

If you lose power, keep the boat headed into the waves by using the anchor.

Learn the storm signals.

DAYTIME WARNING	DESCRIPTION	NIGHTTIME WARNING
	<b>Small Craft Advisory</b> - Winds greater than 18 knots, sustained for two hours or more or hazardous wave conditions. Following a storm, hazardous wave conditions can persist long after the high winds have subsided.	
	<b>Gale Warning</b> - Sustained winds (2 or more hours), of 34-47 knots.	
	<b>Storm Warning</b> - Sustained winds of 48 knots or greater.	
	<b>Hurricane Warning</b> - Forecast winds of 64 knots and above. Displayed only in connection with a hurricane.	

COB\_0032\_A

It is best to avoid operating your boat in foggy weather. When fog sets in, use your GPS and radar unit, if equipped, to take bearings and log courses and speeds. You are required to emit a five-second blast from your horn or whistle once every minute. Additionally, have passengers wear PFDs and observe for oncoming vessels.

### Skill/Experience

#### **⚠ WARNING**

**Avoid injury or death from drowning. Wear your Personal Flotation Device and remain seated when operating the boat.**

Practice your boat operating skills often in calm water. Avoid windy conditions and rough water. Be sure to maintain good visibility at all times. Do not practice close to any obstructions such as piers, bridges, swim areas or moored boats.

Proceed slowly and give yourself plenty of time to react. Remember, your boat is not an automobile. It requires additional time to maneuver and stop.

### Visibility

#### **⚠ WARNING**

**Avoid injury or death. Maintain clear visibility at all times. If necessary, arrange passengers and equipment. Designate a passenger to assist when visibility is limited due to operating conditions.**

Visibility is not only sight, but also hearing. It is very important the operator maintains good visibility at all times. Arrange passengers and equipment to ensure you have unobstructed vision at all times. Check for other boats or any obstacles before turning the boat.

### Drugs/Alcohol

#### **⚠ WARNING**

**Avoid injury or death from impaired operation. Federal and state law prohibit operating a boat under the influence of alcohol and other drugs. These regulations are actively enforced.**

Boating, alcohol and the use of other drugs just do not mix. Mixing boating, alcohol and other drugs results in many marine accidents and deaths. These substances reduce your reaction time and affect your better judgment. Combined with the sun, wind, waves and noise of other watercraft, the effects of drugs are increased and will significantly reduce your reaction time. Do not operate your boat under the influence of alcohol or other drugs. As the owner/operator, you are responsible for the alcohol/drug use and onboard behavior of your passengers.



KC-0153C

If the operator's blood alcohol content is above the state's legal limit, violators are subject to a civil or criminal penalty, imprisonment or both. Operating a boat under the influence can also result in a loss of automobile driving privileges.

### Passengers

Whenever you are going for an outing, make sure that at least one passenger is familiar with the operation and safety aspects of the boat in case of emergency. Show all passengers the location of emergency equipment and explain how to use it. Do not allow passengers to drag their feet or hands in the water, or sit on the bow, deck, gunwale or transom platform while engines are running.

### Ventilation

Your Cobalt boat may be equipped with carbon monoxide (CO) detector(s), if your boat is a cabin type or built with an enclosed changing area.

# RESPONSIBILITIES AND SAFETY

## DANGER

**Avoid the possibility of injury or death from exposure to carbon monoxide (CO). All gasoline and diesel engines and fuel burning appliances such as heaters, stoves and generators produce CO. CO is a colorless, odorless and dangerous gas. Direct and prolonged exposure to CO will cause brain damage or death. Signs of exposure to CO include nausea, dizziness, drowsiness, ears ringing, headaches, unconsciousness and cherry red skin color. Avoid exposing your passengers or yourself to carbon monoxide. Test the carbon monoxide detector operation before each trip, at least once a week and after the boat has been in storage. DO NOT tamper with the operation of the carbon monoxide detector. It is installed for your safety.**

A carbon monoxide (CO) detector will only detect the presence of carbon monoxide gas at its sensor and will not detect other vapors such as gasoline. Carbon monoxide may be present in other areas.

Carbon monoxide poisoning should not be confused with seasickness, intoxication or heat stress. If someone complains of irritated eyes, headache, nausea, weakness or dizziness, or you suspect carbon monoxide poisoning, immediately move the person to fresh air, investigate the cause and take corrective action. Seek medical attention if necessary.

To reduce CO accumulation:

- Ventilate the boat interior by opening the deck hatches, windows and cabin door to provide adequate ventilation.
- Do not operate the engines or generator with the canvas installed.
- Avoid idling or using the generator while at idle for extended periods.

Blockage of boat exhausts by obstruction.

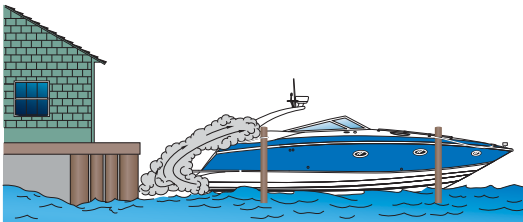

Operating with high bow angle.

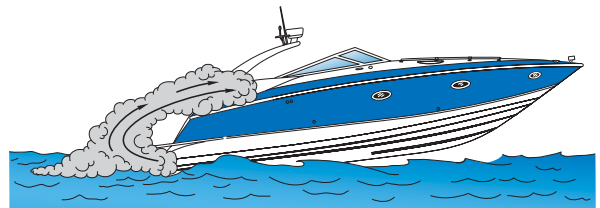

Exhausts traveling along obstruction.

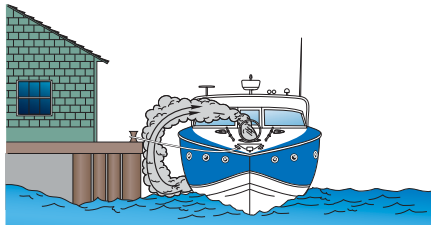

Exhausts from other vessels in confined areas.

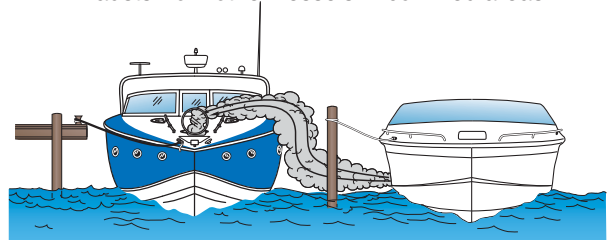

Operating at slow speed or while dead in the water.

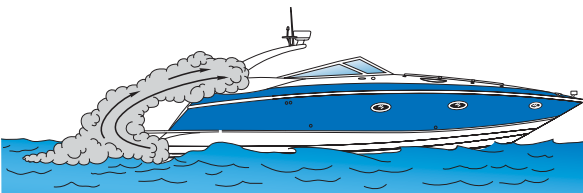

Operating with canvas tops and side curtains in place without ventilation.



COB\_0033\_A

### Qualified Boat Operators

This manual is not intended to provide complete training on all aspects of boat operation. We strongly recommend that all operators of this boat seek additional training on boat handling and safety. Have all operators become familiar with the handling characteristics, and proper steering and control system usage before attempting high-speed operation.

Some states require youths 16 years of age and younger to complete a boating safety course before operating any watercraft. Many others require operators under the age of 18 to be licensed in small boat operation.

Minors must be supervised by an adult whenever operating a boat. Many states have laws regarding the minimum age and licensing requirements of minors. Be sure to contact the state boating authorities for information.

### Safety While Boating

Your Cobalt boat is affixed with various safety labels at the time of manufacture. These labels appear at specific locations on the craft where safety is of particular concern. Refer to *Section 1, Warning Labels*.

Safety labels must remain legible. If you suspect a label is missing or becomes damaged, contact your authorized Cobalt dealer for immediate replacement.

### Federal, State and Local Regulations

The USCG is the authority of the waterways; it is there to help the boating public. State boating regulations are enforced by local authorities. You are subject to marine traffic laws and “Rules of the Road” for both federal and state waterways; you must stop if signaled to do so by enforcement officers, and permit to be boarded as asked.

### Discharge of Oil

The discharge of fuel, oil and other chemicals into the water is prohibited. Be sure to clean up all fuel and oil spillage in the bilge using rags and sponges. Properly store and dispose of them when you get to shore. Do not allow any fuel or oil spills to be pumped out into the water. If fuel or oil leaks continue to be a problem, immediately have the problem repaired.

When refueling, do not “top-off” the fuel tanks. Allow for expansion which will reduce fuel spills from the fuel tank vents.

### Solid Waste Disposal



**NOTICE: It is illegal to dispose of any plastic trash into waters of the U.S.**

The disposal of solid waste and plastics into the water is prohibited. Bag all refuse and properly dispose of it when you get ashore.

### Marine Sanitation



**NOTICE: Direct disposal of sanitation waste into some waters could result in fines. Be sure to check local regulations.**



**NOTICE: Avoid damage to the waste disposal system and the environment. Do not place facial tissues, paper towels or sanitary napkins in the head.**

Have your authorized Cobalt dealer properly service the waste disposal system when needed.

### Excessive Noise

Noise limits are regulated in many areas. Be sure to follow regulations and be courteous.



# RESPONSIBILITIES AND SAFETY

## Wake/Wash

 **WARNING**

**Avoid injury, death or damage to property. Observe “No Wake” markers. Use caution when operating around smaller crafts, in channels and marinas, and in congested areas. You are responsible for injury and damage caused by your wake.**

## Reporting Accidents

The USCG requires the owner or operator of a boat involved in an accident to report the incident to the proper marine law enforcement agency for the state in which the accident occurred.

Immediate notification to the nearest state boating authority is required if a person dies or disappears as a result of a recreational boating accident. If a person dies or sustains injuries requiring more than first aid, a formal report must be filed within 48 hours of the accident. A formal report must be filed within 10 days for accidents exceeding \$500 in property damage or complete loss of boat.

## Rendering Assistance

If you see a distress signal or suspect a boat is in trouble, you must assume it is a real emergency and render assistance immediately. By law, the operator in charge of the craft is obligated to provide assistance to any individual in danger if such assistance can be provided safely. Failure to render assistance can result in a fine and/or imprisonment.

The 1971 Boating Safety Act grants protection to a “Good Samaritan” boater providing good faith assistance, and absolves a boater from any civil liability arising from such assistance.

## Water Sports Safety

Larger boats produce a larger wake which may be too big for skiers. Only boats equipped with a ski tow eye or ski tow pylon should be used to pull water skiers. If you use your Cobalt boat for water sports, you should be familiar with water sport safety and hand signals.



**NOTICE: It is unlawful to participate in water sports while under the influence of alcohol or other drugs.**

When participating in water sports, be safe and courteous and follow these guidelines:

- Be considerate to fishermen and others you share the water with.
- Do not perform water sports in congested areas.
- Stay away from navigation markers.
- Stay away from other boats and water sport participants.
- Return immediately to a fallen water sport participant and turn off engines.
- Regularly inspect water sport equipment to ensure it is safe.
- Do not use any fuel burning appliances with a transom exhaust port when swimming from the stern swim platform.

 **DANGER**

**Avoid injury or death. DO NOT practice unsafe water sports.**

- Water sport participants must wear a USCG approved flotation device. A Type III water ski vest is an approved and practical PFD.
- Keep at least 100 ft (30 m) away from all other objects.
- Have an experienced driver and aft-facing observer in the boat when water sporting.
- Do not water sport in shallow water or at night.
- Do not jump from a moving boat.
- Keep a downed water sporter in sight.
- Turn the engine(s) off before you get close to someone in the water.
- Do not use the boarding ladder with engine(s) running.

Skiers and/or passengers are obligated to be aware of the same safety rules as operators. If you are new to water sports, seek certified training before starting. You will find it especially helpful to join a ski club, World Wakeboard Association and/or the U.S.A. Water Ski when it is possible. Always remember the majority of water sport injuries result from impact with other objects.

Always look where you are going and be aware of your surroundings.

### Platform Dragging (“Teak Surfing”)

READ, KNOW and UNDERSTAND the information on warning labels and adhere to the boat operation practices described on them. The USCG issued a SAFETY ALERT on August 28, 2001, which covers some issues regarding improper use of the boarding ladder/swim platform. The SAFETY ALERT and portions of the information follow:

Tragic deaths occur from the negligence of unsafe boating and dangerous activities. Experts say, “many of these deaths may have been caused by an invisible hazard, carbon monoxide poisoning.” Taking the risk of swimming under a boarding platform when the engine is running, skiing within 20 ft (6.1 m), or “teak surfing” or “dragging” behind a moving boat, can be fatal. Dangerous activities which can result in serious injury or death are not considered water sports. Cobalt Boats does not promote unsafe boating risks or jeopardizing any boater’s safety. “Teak Surfing” or “Platform Dragging” may be illegal in your state, or the states you operate in.

### **WARNING**

**Avoid injury or death. DO NOT use the swim platform for any other purpose than boarding the boat or preparation of entering the water, and do not use the swim platform when engines are running.**

**Carbon monoxide poisoning should not be confused with seasickness, intoxication or heat stress. If someone complains of irritated eyes, headache, nausea, weakness or dizziness, or you suspect carbon monoxide poisoning, immediately move the person to fresh air, investigate the cause and take corrective action. Seek medical attention if necessary.**

# RESPONSIBILITIES AND SAFETY

## Safety Alert From August 28, 2001:

The United States Coast Guard advised boaters not to “Teak/Drag Surf.” Recent boating fatalities revealed carbon monoxide (CO) emitted from a vessel’s exhaust resulted in CO poisoning and death. Do not allow persons in the vicinity of the Swim Platform (in the water or in the boat) with the engine(s) or generator operating, while at rest or underway at slow speed. “Teak/Drag Surfing” places the individual in a position directly exposed to the CO in the engine’s exhaust. This can result in a loss of coherent responses and even death. In addition, “Teak/Drag Surfing” dangerously exposes the individual to a possible propeller injury. Since “Teak/Drag Surfing” is done without a life jacket (PFD), it significantly increases the probability of drowning. The Coast Guard stresses, “Teak/Drag Surfing” is a very dangerous activity and advises boaters not to participate in it.

The Coast Guard also stated that carbon monoxide is one of the most dangerous gases. It strikes before you know you are exposed and it impairs in a way that can, and too often does, lead to death. This is why the Coast Guard feels it is critical that CO is avoided in every circumstance.

## Navigation

### Rules of the Road/Sound Signals

The General Prudential Rule regarding right-of-way is that if a collision appears unavoidable, neither boat has right-of-way. As prescribed in the “Rules of the Road,” both boats must act to avoid collision.

The information in this section outlines only the most basic of the nautical “Rules of the Road.” For more information, contact your local USCG Auxiliary.



In general, boats with less maneuverability have right-of-way over more agile craft. You must stay clear of the vessel with right-of-way and pass to his stern.

## Whistle/Horn Signals

Signaling other boats with a whistle or horn is similar to using turn signals on an automobile. It is not necessary to sound a signal every time a boat is nearby. In general, boat operators should signal their intention, as to avoid potentially confusing or hazardous situations.

It is customary for the privileged boat to signal first, and the burdened boat to return the same signal to acknowledge she understands and will comply. Use the danger signal (five or more short and rapid blasts) if intent is not clear.

Use the following signal blast early enough to be noticed and understood by other boaters:

- One long blast: Warning signal (coming out of slip or passing astern)
- One short blast: Pass on my port side
- Two short blasts: Pass on my starboard side
- Three short blasts: Engines in reverse
- Five or more short and rapid blasts: Danger signal!

## Privileged Boats

Privileged boats have right-of-way and can hold course and speed. Sailboats and boats paddled or rowed have the right-of-way over motor boats. Sailboats under power are considered motorboats. Small pleasure craft must yield to large commercial boats in narrow channels.

## Burdened Boats

The burdened boat is the boat that must make the necessary adjustment to course and speed to keep out of the way of the privileged boat.

### Crossing Situation

In crossing situations, the boat to the right from the 12 o'clock to the 4 o'clock position has the right-of-way. It must hold course and speed. The burdened boat keeps clear and passes behind the privileged boat. Boats going up and down a river have the privilege over boats crossing the river.

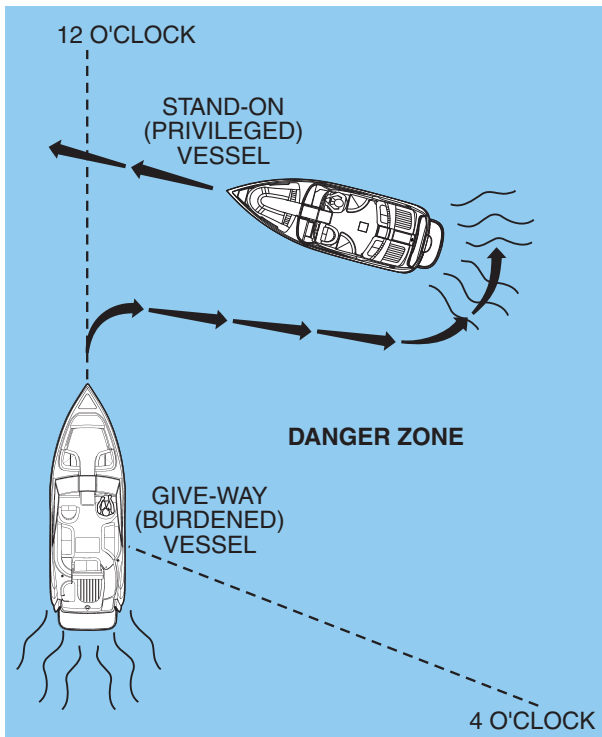

### Meeting Head-On

Neither boat has the right-of-way in this situation. Both boats should decrease speed, should turn to the right and pass port-to-port. However, if both boats are on the left side of the channel, each vessel should sound two short blasts and pass starboard-to-starboard.

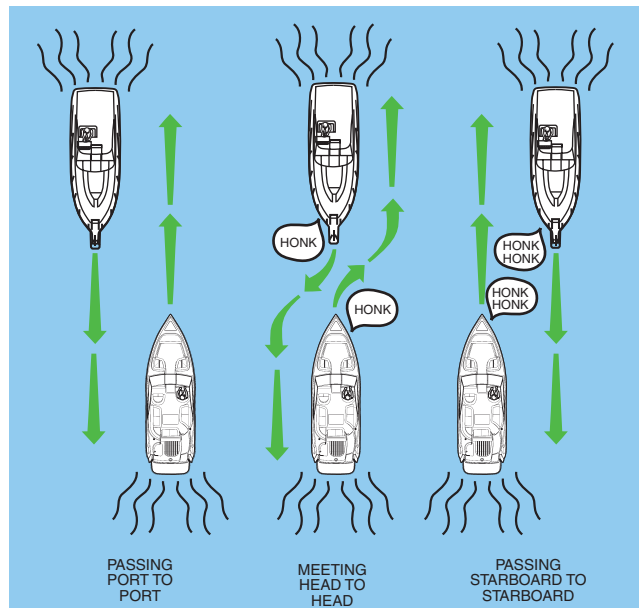

# RESPONSIBILITIES AND SAFETY

## Overtaking

The boat that is overtaking one ahead of it is the burdened boat and must make any adjustments necessary to keep out of the way of the privileged boat. The privileged boat should hold its course and speed.

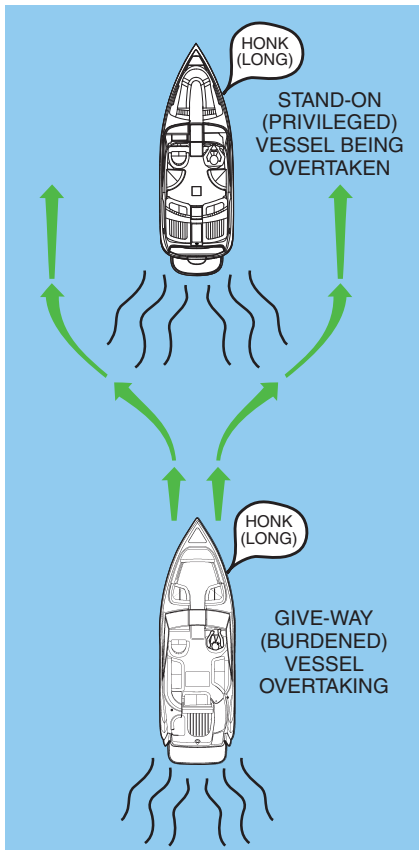

COB\_0035\_A

## Special Situations

Boats operating between sunset and sunrise (hours vary by state) must use navigational lights, nighttime operation, especially during bad weather or fog can be dangerous. All “Rules of the Road” apply at night; it is best to slow down and stay clear of all boats, regardless of who has right-of-way.

Protect your night vision by avoiding bright lights and have a passenger, if possible, help keep watch for other boats, water hazards and aids to navigation.

The size, speed and direction of the other vessels are determined at night from their running lights. A green light indicates the starboard side of the boat, and a red light indicates the port side. Generally, if you see a green light, you have the right-of-way; if you see a red light, give-way to that vessel.

## Aids to Navigation

Learn to recognize the different buoys and day markers; they are the signposts of the waterways. The United States Aids to Navigation System (USATONS) is the primary marking system used on inland water, coastal waters and rivers. This system is maintained by the U.S. Coast Guard (USCG).

## Types of Buoys

There are several types and shapes of buoys. Buoys may be unlighted, lighted, with sound or may have both an audible and a visual signal. Lights, bells and horns are used on buoys for night or poor visibility conditions. Different shapes of buoys are shown below.



UNLIGHTED BELL BUOY



SPAR BUOY



CAN BUOY



LIGHTED BUOY



NUN BUOY



SPHERICAL SAFE WATER MARKER

KC-1908

Buoys with unique light-flashing characteristics are identified on nautical charts with the specific flashing pattern.

### Mooring Buoys

The only buoys you are permitted to moor to are mooring buoys. Mooring buoys are white with a blue horizontal stripe. Mooring to a navigation buoy, regulatory markers or lateral markers is illegal.



KC-1901

### Regulatory Markers

Regulatory markers indicate dangerous or restricted controlled areas. These markers are used to indicate speed zones, areas set aside for particular use, general information and directions.

Regulatory markers are white with orange geometric shapes and also have orange bands near the top and at the water line of the buoy. You must obey regulatory markers (see below).

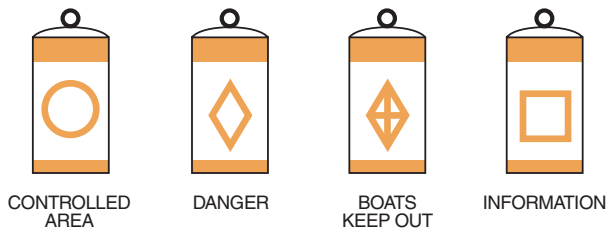

KC-1903

# RESPONSIBILITIES AND SAFETY

## Lateral Markers

Lateral markers are oriented from the perspective of being entered from seaward (the boater is going toward the port). This means that red buoys are passed on the starboard (right) side of the vessel when proceeding from open water into port, and green buoys to the port (left) side.

The right side (starboard) of the channel is marked with RED, even-numbered buoys. The left side (port) of the channel is marked with GREEN, odd-numbered buoys.

Day markers are colored and numbered the same as buoys. RED, triangular day markers with even numbers mark the starboard side of the channel.

GREEN, square day markers with odd numbers mark the port side of the channel.

Fairways and mid-channels may be marked with safe water marks or buoys. These marks indicate safe water all around. Safe water marks are red and white striped and are round or have a red spherical topmark.

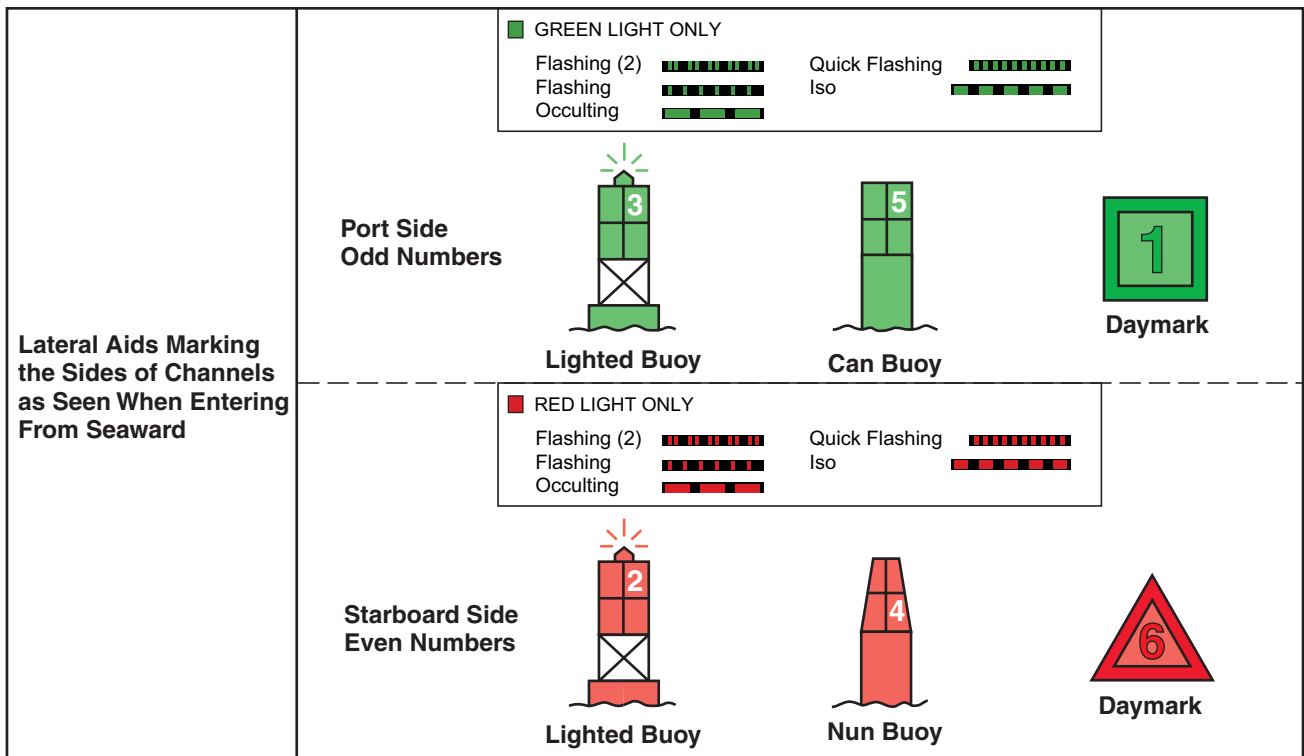

KC-1909

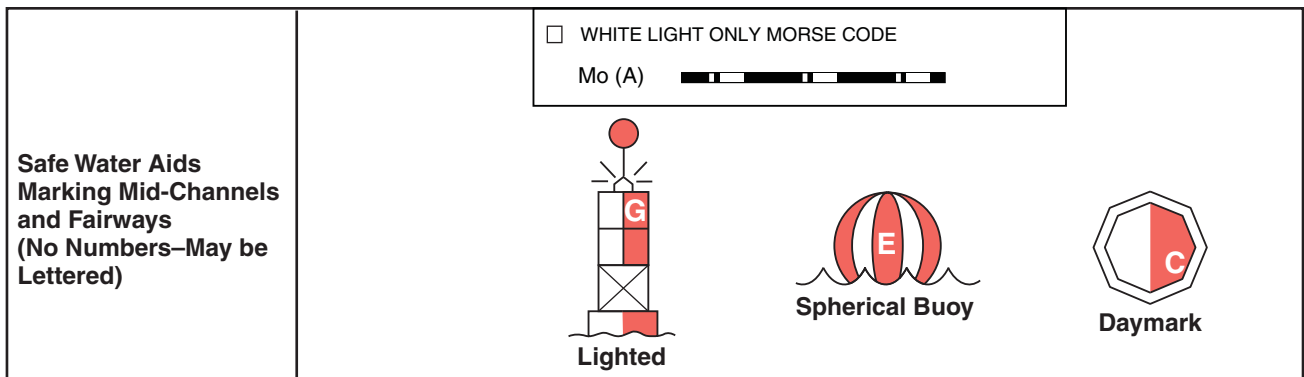

KC-1910

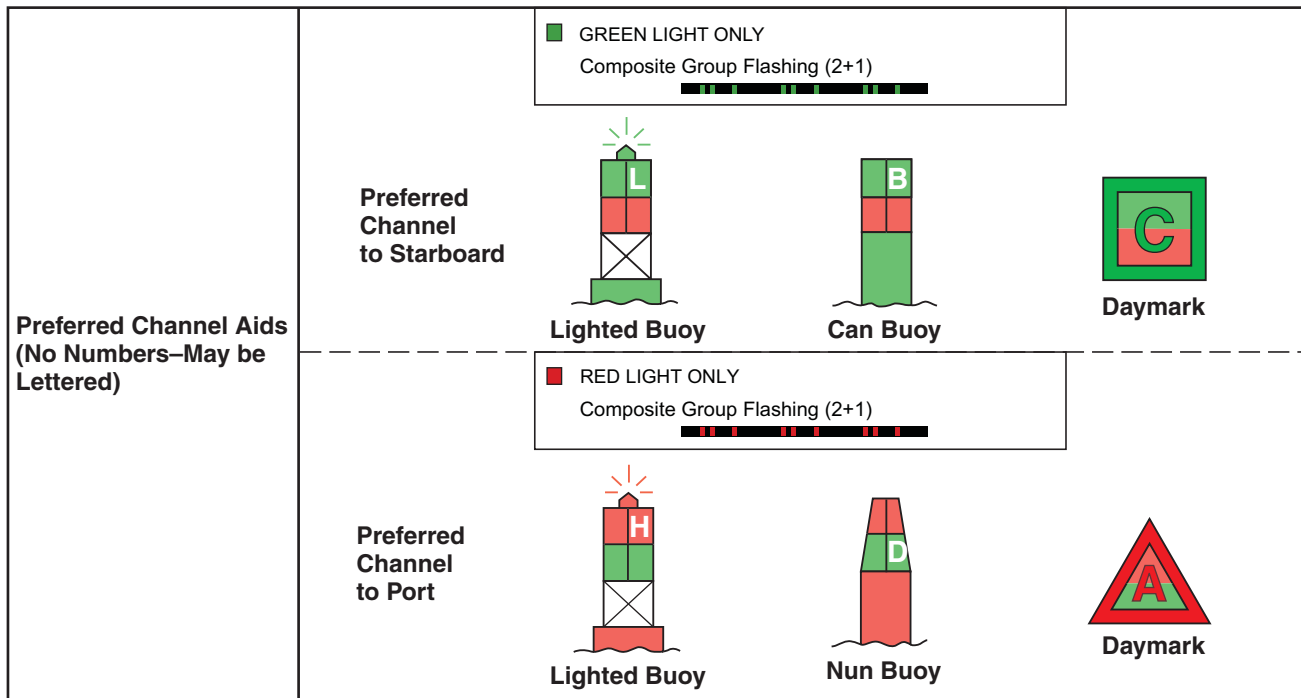

KC-1911

Obstructions, channel junctions, etc. are marked with RED and GREEN horizontally striped buoys.

A RED band at the top means the preferred channel is to the left of the buoy; a GREEN top band means the preferred channel is to the right of the buoy.



# RESPONSIBILITIES AND SAFETY

## Isolated Danger Markers

Isolated danger markers indicate an isolated danger which may be passed on all sides. These markers are colored black with one or more broad horizontal red bands and are equipped with a topmark of two black spheres, one above the other.

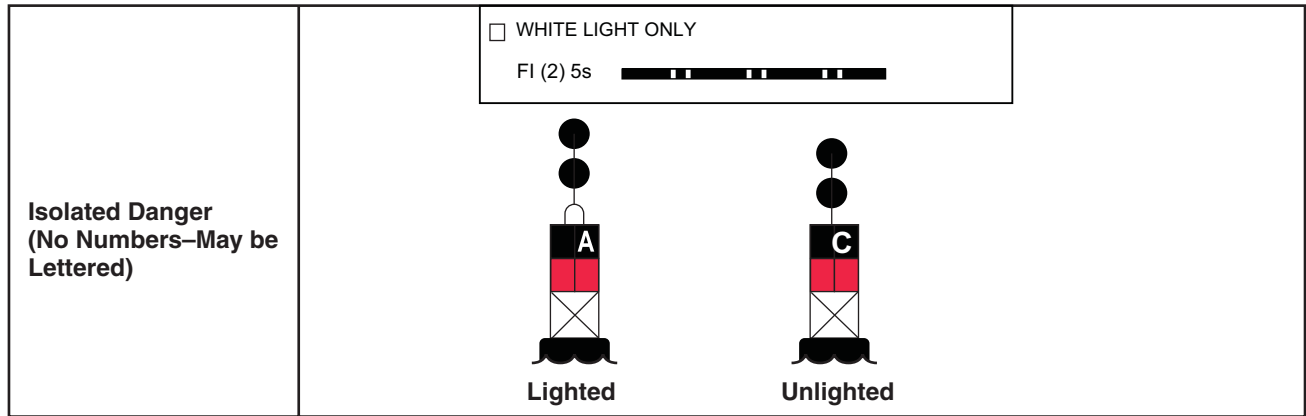

KC-1912

On inland waters, a buoy with alternating vertical black and white stripes may be used to indicate that an obstruction or other danger exists between the buoy and the nearest shore. DO NOT pass between the buoy and the shore.

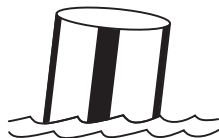

BLACK-STRIPED  
WHITE BUOY

KC-1902

## Light Structures

Maneuvering a boat at night can be dangerous and confusing. To aid boaters with navigation and warn of hazards, the USCG and the state and local authorities maintain a variety of light structures. Some light structures may be equipped with radio beacons, radar reflectors and/or signals.

## Minor Lights

Minor lights are colored according to the buoyage marking system in use. They are similar to lighted buoys, except they are usually higher and on more stable platforms to increase visibility. Most minor lights are part of a series to mark a channel, river or harbor.

### Range Lights

Range lights are usually visible in one direction and help a boat operator navigate in a generally safe direction. Steering a course to keep range lights arranged in a line (one on top of the other) will help guide a boat through a channel.

RANGE LIGHTS

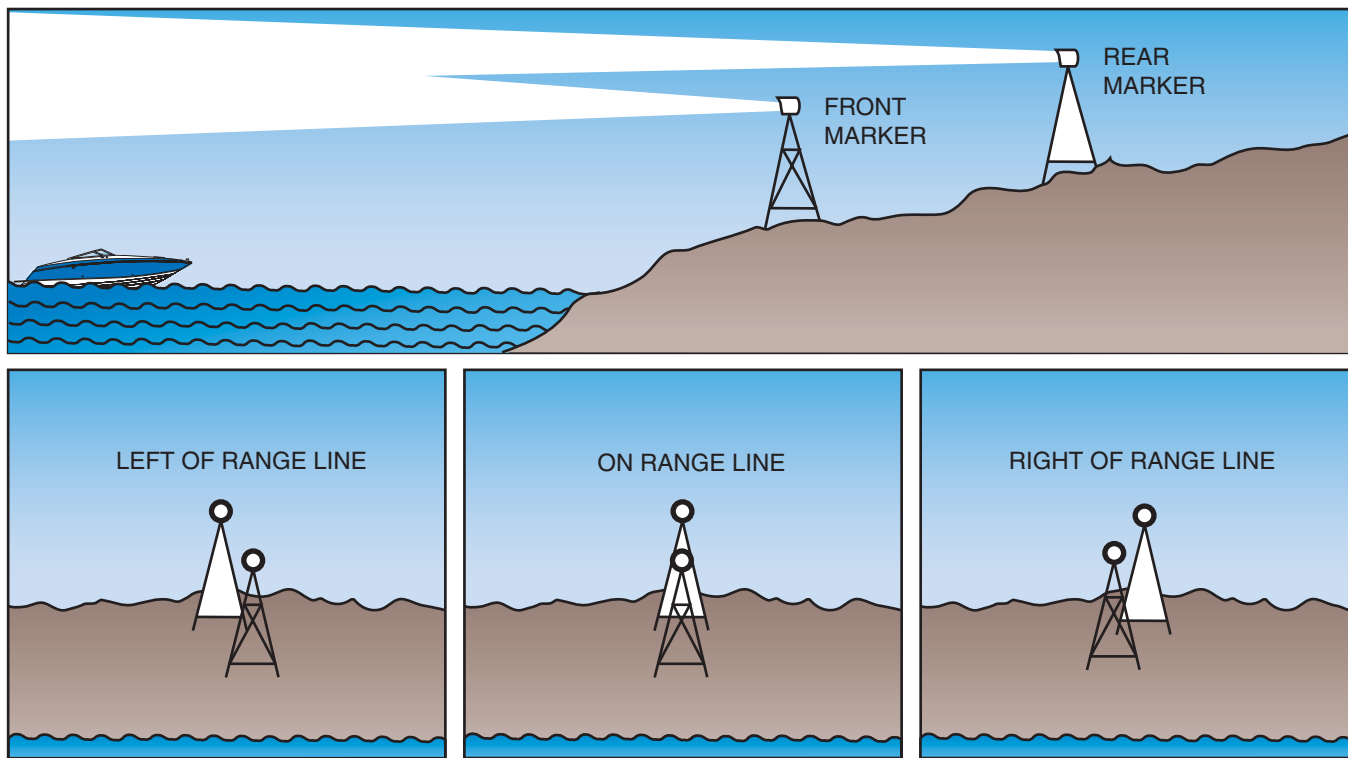

COB\_0038\_A

### Lighthouses

Lighthouses can be found at harbor entrances, prominent headlands, isolated danger areas and along the coast. These striped or patterned structures have unique flashing characteristics to help identify them.

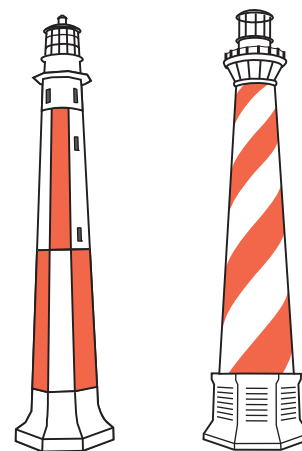

KC-0443C

# RESPONSIBILITIES AND SAFETY

## Warning Markers

DIVERS FLAG



USED BY  
RECREATIONAL  
DIVERS -  
INDICATES  
DIVER'S  
POSITION

ALPHA FLAG

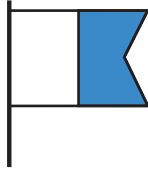

WORLDWIDE  
VESSELS  
ENGAGED  
IN DIVING  
OPERATIONS -  
DOES NOT  
INDICATE  
DIVER'S  
POSITION

DISTRESS FLAG



INDICATES  
FELLOW  
BOATER IS IN  
NEED OF  
ASSISTANCE

COB\_0039\_A

It is a good idea to ask local authorities if there are hazardous areas in the waters in which you plan to boat, and how they are marked. Boaters must also recognize the flag designs which indicate that skin divers are present and keep well clear of the area.



KC-0250C

Watch for swimmers. Swimming areas may not be marked. Steer clear from the area and remain alert.

**NOTES**



# OPERATING INFORMATION

This section is not intended to provide complete training on all aspects of boat operation.

We strongly recommend that all operators of this Cobalt boat seek additional training on boat handling and safety. Have all operators become familiar with the handling characteristics and proper steering and control system usage before attempting operation and especially high-speed operation.

The features described in this section are standard or optional, depending on your model. Refer to **Standard and Optional Equipment**, in this section, for a list of features for this model.

## PRECAUTIONS

### Before You Start

Become familiar with the location and operation of all equipment. Have emergency plans in place. Be sure to perform a safety check before operating your boat.

### Fire/Explosion

Most fires are the result of fuel and oil accumulating in the bilge from careless fueling practices. Use the fire extinguisher at the base of the flames using a sweeping motion. Prudent and accurate use of the available chemicals should contain all but the worst fires. Verify that the fire has been extinguished. If so, check damage and get assistance immediately. If not, get out and swim at least 25 yards (23 meters) upwind from the boat and use the visual distress signals to get assistance. Refer to *Section 2, Safety*, for additional information.

## FIRST-TIME OPERATION

### **⚠ WARNING**

**Avoid injury or death. Improper operation can be extremely hazardous. Read and understand this manual, the propulsion unit operator's manual and any other accessory or components of your boat. Be sure that you understand all controls and operating instructions before attempting to operate the boat.**

Your safety, the safety of your passengers, and the safety of other boaters are among your responsibilities as operator of this boat.

Your boat must be in compliance with USCG safety equipment regulations.

You should know how to react correctly to adverse weather conditions, have good navigation skills and follow the "rules of the road" as defined by the USCG and state, county and local regulations.

We cannot stress enough the importance of reading your propulsion unit operator's manual and following the manufacturer's instructions for breaking in your engine.

Before each outing you should check all safety equipment, such as fire extinguishers, PFDs, flares, distress flags, flashlights and engine stop switch. They should be operable, in good condition, readily visible and easily accessed.

### FUEL

#### Fuel Requirements

Cobalt fuel systems are designed to meet all current ABYC and NMMA regulations using gasoline with up to 10% ethanol.

#### WARNING

**DO NOT use fuels containing methanol (methyl alcohol) or other fuels with more than 10% ethanol (ethyl alcohol) content such as E85, which contains 85% ethanol.**

Fuel that contains more than 10% ethanol voids all warranties and will increase the risk of damage to the engine, fuel system components and will also lead to the following:

- Corrosion of metal parts
- Deterioration of plastic, rubber parts or permeation of fuel through rubber fuel lines
- Leaking fuel resulting in explosion and/or fire
- Starting and operating difficulties
- Potential damage to your engine

#### Fueling

Take care not to spill gasoline. If gasoline is accidentally spilled, wipe up all traces of it with dry rags and immediately dispose of the rags properly ashore. Spilled fuel may yellow the gelcoat finish and damage gunwale trim.

#### DANGER

**Avoid injury, fire or explosion. Take all precautions every time you fuel your boat, regardless of the fuel type. Certain fuel is extremely flammable and highly explosive under certain conditions. Fumes from rags can collect in bilge and be extremely hazardous. Operate the blowers for at least four minutes. DO NOT store rags used to wipe up fuel or solvent spills in the boat. Dispose of rags properly ashore.**



**NOTICE:** Prevent unwarranted engine damage. Use the recommended fuel type and octane rating. Refer to your propulsion unit operator's manual.

#### DANGER

**Avoid injury, fire or explosion. Fuels are extremely flammable and highly explosive under certain conditions.**

- Stop engines, generators and any fuel operated machinery.
- **DO NOT smoke or allow open flames or sparks within 50 ft (15 m) of the fueling area.**
- **Avoid damaging fuel lines and connectors, and the contact of fuel on hot engine parts.**
- **DO NOT store fuel in any containers or compartments which are not designated for fuel storage.**
- **Clean up any spilled fuel immediately and dispose of rags properly ashore.**
- **Know the dangers associated with fuels.**



**NOTICE:**

- Each time you refuel, inspect all fuel lines, hoses and connections for leaks and deterioration.
- The Federal Water Pollution Control Act prohibits the discharge of oil or oily waste into the water. Violators can be fined \$5,000.00. We urge you to protect our fragile environment by avoiding any type of discharge, trash or litter into our waterways.

# OPERATING INFORMATION

## When Fueling:

1. Know your fuel tank capacity. Be sure to have enough fuel to reach your destination. If departing for an extended cruise, know the availability of fuel along your route. Practice the One Third Rule: one third to reach the destination, one third to return and one third in reserve.
2. Avoid fueling at night, except under well-lighted conditions.
3. Moor your boat securely to the dock. Know the location of the fire extinguisher in case of emergency.
4. Keep accurate records of your fuel consumption. A fuel log tracking fuel use over time will help determine average consumption.
5. Close all doors, hatches, windows and other compartments.
6. Extinguish cigarettes, pipes and all other flame producing items.
7. Make sure all power is off, and do not operate any electrical switches.
8. Remove the fuel filler cap.
9. Insert the hose nozzle and make sure nozzle is in contact with or grounded against fill opening. This will reduce the risk of static spark.

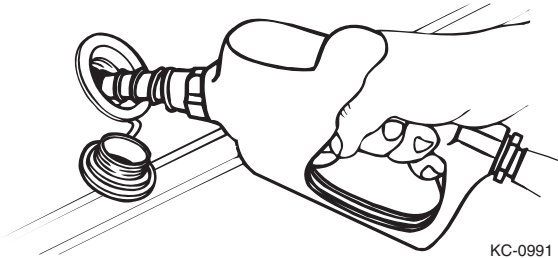

When your boat is equipped with the pop-up fuel filler cap, open by pressing the cap and turning the cap counterclockwise (approximately 10°); remove cap.

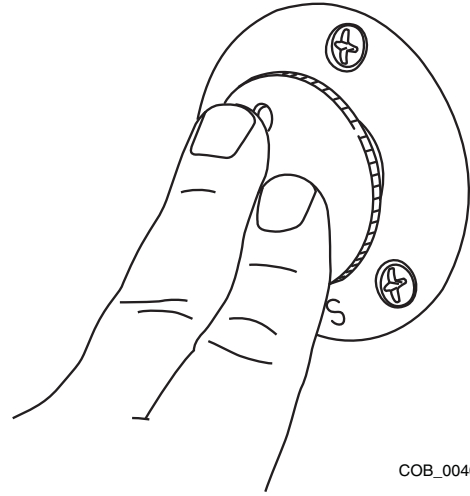

To close:

Reinstall cap, press and turn clockwise. The fuel cap key is not necessary unless the cap is overtightened.

10. Add fuel in accordance with the propulsion unit operator's manual. Do not overfill, and allow enough room for fuel expansion.

The fuel cap is retained by a chain, to prevent losing the cap after it is opened. Be careful when fueling to avoid damaging the chain. If it breaks, have it replaced.

## After Fueling:

1. Tighten the fuel fill cap using the fuel cap key, unless your filler cap is the pop-up type. Wipe up any fuel spills.
2. Open all windows, hatches, doors and compartments.
3. Check all fuel lines, hoses and connections for leaks and deterioration.
4. Be sure to run the blower for at least four minutes before starting the engine. If you smell gasoline fumes, do not start the engine; continue to run the blower until fumes have dissipated.

### EPA Fuel Tank

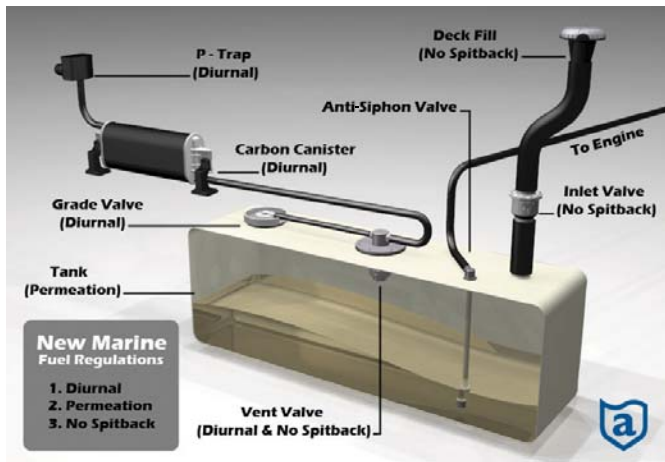

COB\_0341\_A

Your Cobalt boat may be equipped with a fuel system that has been designed and manufactured to meet the latest U.S. Coast Guard and EPA EVAP (evaporation) regulations. A decal located at the helm will indicate if your boat is equipped with this fuel system.

Some of the new features in the fuel system:

- There is no “spitback” at the deck plate when fueling. The filler nozzle automatically shuts off when the tank is full. Do not attempt to continue fueling after the nozzle automatically shuts off, indicating the tank is full.
- A carbon canister is present to capture hydrocarbon molecules before air is vented outside the fuel system.

When filling the tank for the first time:

- Fuel vapor will expand within the tank, causing back pressure that may close the inlet check valve and cause the filler nozzle to prematurely shut off. To eliminate this problem, slowly add only about 2 gal (7.5 L) of fuel and stop. Wait a few minutes to let the pressure within the system stabilize; then proceed filling the tank.
- During the first few fills, the new carbon canister within the vent line may generate heat from being initially saturated with hydrocarbons and cause water droplets to emit from the outside air vent. This is normal. After the first two or three fills, this should not happen.

### Troubleshooting

**New tank is hard to fill / nozzle keeps shutting off:**

This is called the “Green Tank Effect.” With a new tank that has never seen fuel before, you must let the internal tank volume become completely filled with the fuel vapor, very similar to what occurs in non-diurnal tanks currently. The difference is now you do not get the huge amount of spitback; instead the nozzle just shuts off. When filling a tank for the first time, the fuel vapor expands and builds back pressure, shutting the inlet check valve and causing the nozzle to shut off.

To eliminate this problem, add a few gallons to the tank very slowly and let sit for several minutes. Then proceed with normal filling.

**Hot air comes out of vent and it drips liquid:**

This is completely normal. When you fill a tank for the first time, the canister becomes saturated with hydrocarbons and generates heat as it performs its intended function. The water from the vent is just water vapor condensation as a result of the carbon canister operating correctly and stopping hydrocarbons (fuel vapor) from venting to the atmosphere. After the first two or three fills, the system will stabilize and these issues will go away.

**Cannot “top off” / keep filling tank after it shuts off:**

This is due to EPA regulations preventing overfilling the tank to prevent expansion from causing fuel to overflow through the vent.

**DO NOT CONTINUE TO FILL THE TANK ONCE IT IS FULL AND THE NOZZLE SHUTS OFF.**



# OPERATING INFORMATION

## LAUNCHING

### Launching Checklist

Federal and local laws require certain safety equipment to be onboard at all times. In addition, responsible boaters carry other equipment in case of an emergency. Check with local boating authorities for any additional requirements over and above federal requirements.

For maximum enjoyment and safety, check each of these items BEFORE launching:

- Install drain plug.
- Have enough personal flotation devices for every person onboard.
- Be sure the steering system operates smoothly and properly.
- Verify the amount of fuel in the fuel tanks.
- Verify the batteries are fully charged.
- Check weather conditions.
- Be sure the lights, horn, bilge pumps and other electrical equipment are in proper operating condition.
- Be sure the fire extinguisher, signaling devices and other emergency gear are onboard and in proper operating condition.

### On the Water

Start your engine before casting off. Remember, the boat turns from the stern. Allow plenty of space between the boat and the dock before trying to move away.

### Boarding

When boarding the boat, always step in. Do not jump. Avoid stepping on fiberglass or other potentially slippery surfaces. Board one person at a time.

Do not board the boat while carrying gear. Set the gear on the dock, board the boat and then pick up the gear.

### Loading

Do not overload your boat. The performance of your boat is dependent on load weight and distribution. Passengers should distribute themselves to maintain trim. Remember to distribute weight from right to left, and also from front to back.

- Avoid excess weight in the bow or stern.
- Securely stow all extra gear in stowage areas to prevent load shifting. Do not stow gear on top of safety equipment; safety equipment must be quickly accessible.
- In adverse weather, reduce the load in the boat. People/load capacity ratings are based upon normal boating conditions.
- Do not use the drive unit as a boarding ramp; use the boarding ladder. To prevent injury, make sure the engine is off when swimmers, divers and skiers are boarding.

Overloading of passengers, personal equipment and supplies could result in an accident, especially in rough waters. Maintain a balanced load at all times.

### Shipshape

Keep the weight distributed evenly. Store all gear in secure areas. Safety equipment must be immediately accessible at all times.

 **DANGER**

**Avoid injury or death. All passengers should be carefully seated while the boat is moving. DO NOT sit on the bow, bow pulpit, deck, gunwale or sundeck pads when the boat is moving.**

### GETTING UNDERWAY

There are many things to consider when planning a safe and enjoyable boating trip.

You are responsible for the safety of all passengers, the boat and any damage the boat or its wake may cause. Keep passengers from blocking your view so that you do not run into other boats, swimmers, water skiers, personal water vehicles or aids to navigation.

#### Before Starting Checklist

The following checks are essential to safe boating and must be performed before starting the engine. Get into the habit of performing these checks in the same order each time so that it becomes routine.

#### Propulsion System

 <b>WARNING</b>
<p><b>Always check bilge and engine compartment for fuel fumes before starting the engine. If there is an odor of fuel, do not start the engine until the problem has been fixed and fumes have been eliminated.</b></p> <p><b>Always keep hands, feet, hair and clothing away from water intake and drive unit. Do not attempt to clear debris or perform other maintenance while the engine is running.</b></p> <p><b>Always remove the clip from the emergency stop switch to prevent accidental starting of the engine while working on the propulsion system.</b></p>

<b>CAUTION</b>
<p><b>Do not exceed the posted engine rating of your boat. Boat power capacity has been rated for maximum performance and safety. Exceeding power capacity is illegal in many areas.</b></p> <p><b>Never use a propeller that allows the engine to exceed recommended RPM under normal wide-open throttle operation.</b></p>

#### Pre-Operation:

- Refer to *Section 5, Before Every Use*.
- Refer to **Launching Checklist**, in this section.
- Test operation of carbon monoxide detectors.
- Open all seacocks and check for leaks.
- Check seawater strainers for leaks and accumulation of debris.
- Open windows, doors and hatches.
- Check that no fuel, oil or water is leaking or has leaked into the bilge compartment.
- Check all hoses and connections for leaks and damage.
- Verify the shift lever is in the NEUTRAL position.
- Check that the steering system operates properly.

 <b>DANGER</b>
<p><b>Avoid injury or death. DO NOT operate the boat if any problem is found during this inspection. A problem could lead to an accident when using an unsafe boat. Immediately have any problem attended to by your authorized Cobalt dealer.</b></p>

- Operate bilge blowers for at least four minutes before starting engines or generators.
- Do not overload your boat.

#### During Operation:

- Check gauges frequently for signs of abnormal operation.
- Check that steering, shift and throttle controls continue to operate smoothly.
- Check for excessive vibration.
- Monitor your fuel supply.
- Verify batteries are charged.

#### After Boating:

- To prevent marine growth from accumulating on the hydraulic cylinder shafts, make sure trim tabs are up and propulsion unit drives are in the full trim DOWN position.
- Remove the ignition keys.

# OPERATING INFORMATION

- Close all water inlet seacocks.
- If possible, inspect the hull and propellers for damage.
- Clean any spills, stains or moisture from the boat. Inspect sea strainers.
- Remove any food, garbage and wet gear from the boat.
- Secure lockers, hatches and canvas as equipped.
- Verify that bilge pumps operate properly and pump the bilges dry with manual switch.
- Clean the bilge and check for fuel, oil and water leaks.
- Stow PFDs and other safety gear and equipment dry.
- Fill fuel tanks (allow for expansion) to prevent condensation.
- Turn battery select switches off.
- Turn off the DC breaker on the electrical panel. If not using shore power, turn off the AC breaker.
- Notify the person with whom you filed a float plan of your return.
- If the boat is removed from the water, wash the hull and deck exterior with fresh water.

## Handling Dock and Mooring Lines

Be sure to use enough fenders to protect your boat from damage. Only use good quality, double-braided nylon line. Protect your boat's finish by using chafing protectors on the lines. Only use the cleats, bow eye and stern eyes to secure your boat. Do not use the handrails or windshield. The foredeck handrails should only be used for tying a "Jackline" in an emergency situation. If possible, tie up your boat with the bow toward the waves and leave a little slack in the lines to allow for some wave movement or tidal action.

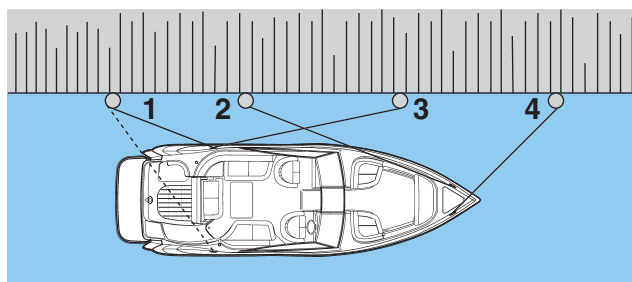

COB\_0060\_A

- 1 – Stern Line
- 2 – Forward Quarter Spring
- 3 – After Bow Spring
- 4 – Bow Line

Use your dock lines to help maneuver the boat near the pier and to secure it. Use the following information to secure your boat to a pile or dock cleat:

The bow line is fastened to the bow cleat and is pulled forward at about a 45° angle. This line keeps the boat from moving astern.

The stern line is fastened to an after cleat and pulled astern at about a 45° angle. This line keeps the boat from moving forward.

The spring lines can help you control the boat when leaving a dock. Be sure to use spring lines when boating in waters where the tide movement is significant. The forward quarter spring line is fastened to a forward cleat and heads aft. The after bow spring is fastened to a stern cleat and heads forward.

### Starting/Shifting/Steering/Stopping

Your Cobalt boat may be equipped with a warning system that will sound an alarm if an engine problem develops. The horn may emit a short chirping sound during starting to verify operation. If the warning horn sounds when operating the boat, IMMEDIATELY throttle back to idle speed and shift into the NEUTRAL position. IMMEDIATELY check the gauges and stop the engine.



**NOTICE: Continued operation after the warning alarm has sounded may cause severe engine damage.**

### Carbon Monoxide Detectors, if equipped

Avoid the possibility of injury or death from exposure to carbon monoxide (CO). All gasoline and diesel engines and fuel burning appliances such as heaters, stoves and generators produce CO. CO is colorless, odorless and dangerous. Direct and prolonged exposure to CO will cause brain damage or death. Signs of exposure to CO include nausea, dizziness, drowsiness, ears ringing, headaches, unconsciousness and cherry red skin color. Avoid exposing your passengers and yourself to carbon monoxide. Test the CO detector operation before each trip, at least once a week and after the boat has been in storage. Do not tamper with the operation of the CO detector. The detectors are installed for your safety.

Carbon monoxide poisoning should not be confused with seasickness, intoxication or heat stress. If someone complains of irritated eyes, headache, nausea, weakness or dizziness, or you suspect carbon monoxide poisoning, immediately move the person to fresh air, investigate the cause and take corrective action. Seek medical attention if necessary.

### Starting the Engine

**⚠ DANGER**

**Avoid death, injury, fire or explosion. Operate the blower for at least four minutes each time you start the engine.**

**In addition, the blower should be operated continuously when at idle and during slow speed operation.**

### Cobalt Checklist

For maximum enjoyment and safety, check each of these items.

BEFORE you start your engine:

- DRAIN PLUG (Securely in place?)
- PERSONAL FLOTATION DEVICES (One for every person onboard?)
- STEERING SYSTEM (Working smoothly and properly?)
- FUEL SYSTEM (Adequate fuel? Leaks? Fumes?)
- BATTERY (Fully charged? Proper water level?)
- ENGINE (In the NEUTRAL position?)
- CAPACITY PLATE (Are you overloaded or overpowered?)
- WEATHER CONDITIONS (Safe to go out?)
- ELECTRICAL EQUIPMENT (Lights, horn, pump, etc.?)
- EMERGENCY GEAR (Fire extinguisher, bailer, paddle, anchor and line, signaling device, tool kit, etc.?)

### RECOMMENDED SAFETY RULES

- REMAIN SEATED WHILE UNDERWAY.
- AVOID USING REAR PAD OR SUNDECK WHILE ENGINE IS RUNNING.
- DO NOT USE BOARDING LADDER WHILE ENGINE IS RUNNING.
- TURN OFF ENGINE AND ALL ELECTRICAL SYSTEMS WHILE REFUELING.
- TURN OFF ENGINE WHEN SWIMMERS ARE NEAR BOAT.

# OPERATING INFORMATION

After launching and pre-start checks and procedures have been followed, the engine can be started. Please refer to the propulsion unit operator's manual for additional starting procedure information.

Start the engine with the shift control lever in the NEUTRAL position. Your boat is equipped with a neutral safety switch which will not allow engine to be started unless the shift control levers are in the NEUTRAL position.

Make sure:

- Control lever is in the NEUTRAL position.
  - Throttle lever is at the IDLE position.
1. Turn the ignition key to START position. Release the key immediately after the engine starts. If the engine fails to start, refer to the propulsion unit operator's manual for additional information.



**NOTICE: Release the ignition key after the engine starts. Do not run the start motor for more than 10 seconds at a time. Failure to follow this procedure can damage an engine and the engine's starter motor.**

2. Operate the engine at approximately 1,000 RPM and check the oil pressure gauge. If oil pressure is not within specified range, stop the engine immediately. Have your authorized Cobalt dealer service the engine.
3. Make sure the water pressure gauge indicates water pressure immediately after starting the engine. If it does not, turn off the engine and contact your authorized Cobalt dealer.
4. Allow the engine to warm up. Check the water temperature gauge to be sure water temperature remains within the specified range.

If the temperature gauge reads abnormally high, stop the engine immediately. Check the drive unit's water inlets for blockage. If the inlets are open, have your authorized Cobalt dealer service the engine.

## Shifting/Running

### CAUTION

**Avoid injury, swamping the boat or taking water in over the transom. Go slowly when traversing in reverse.**

Follow these guidelines when shifting your boat:

- Pause in the NEUTRAL position before shifting from FORWARD to REVERSE, or REVERSE to FORWARD.
- Avoid shifting into REVERSE while the boat is traveling forward at speed.
- Keep the control area clean and clear of obstructions.

## Steering

### ⚠ DANGER

**Avoid injury or death. The steering system is the most important system in the entire boat from a safety standpoint. The boat's steering system is not self-centering. Propeller torque, trim setting, water condition and boat speed affect the steering. Constant attention to the steering system is required for safe operation. Have the system inspected and maintained on a quarterly basis by a qualified service technician.**

Your Cobalt boat is equipped with a tilt steering wheel. Adjust the tilt position with the release lever.

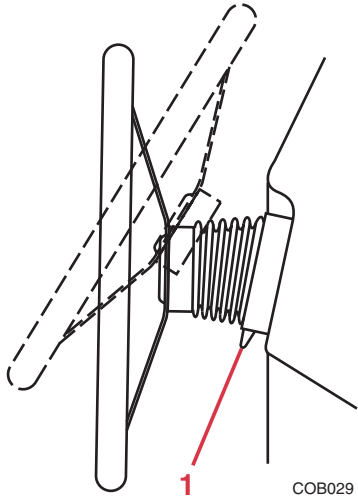

1 – Release Lever

COB029

### **⚠ WARNING**

**Avoid loss of control and/or injury. DO NOT adjust the steering wheel tilt position while the boat is moving. Sudden boat movement may cause loss of balance resulting in loss of control.**

The steering system must be working correctly and properly maintained. Be sure to:

- Keep mooring lines, tow lines and other obstructions clear of the steering system.
- Keep the steering system's moving parts clean and lubricated.
- Regularly inspect the steering system for kinks, damage and corrosion.

Refer to **Basic Maneuvering**, in this section, for additional steering information.

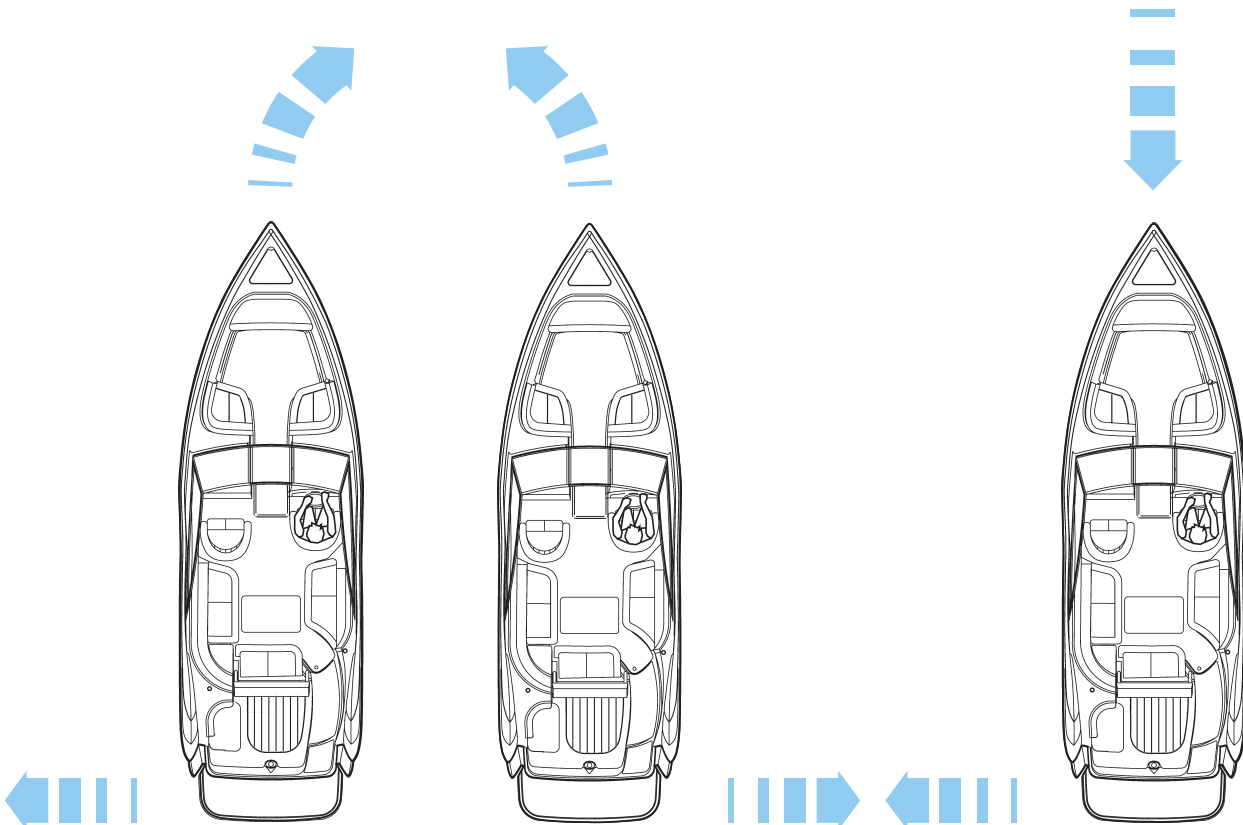

**RIGHT TURN**  
Turn wheel to right—Stern will move to left.

**LEFT TURN**  
Turn wheel to left—Stern will move to right.

**BACKING TO LEFT**  
Turn wheel to left—Stern will pull to left.

COB\_0062\_A

# OPERATING INFORMATION

## Stopping the Engine

### **WARNING**

**Avoid creating a hazardous condition. DO NOT use the engine stop switch and lanyard for normal stopping of the engine. Using the stop switch will impair your ability to restart the engine quickly if a hazardous situation arises.**

1. Slowly bring the throttle lever to the IDLE position, or the NEUTRAL position.
2. Move the shift lever to NEUTRAL.
3. After operating at high speeds, allow a 2-3 minute engine cooldown period at low idle.
4. Turn the ignition key to the OFF position.



**NOTICE: If any problems are encountered during the outing, have your boat inspected by your authorized Cobalt dealer and request any necessary repairs before your next outing.**

## Leaving

Use caution when casting off. Wind, water conditions and other boat traffic will affect your boat's movement. Move slowly and:

- Be sure the engine is warmed up before casting off.
- Have enough space between the boat and the dock to allow you to swing the boat's bow away from the dock. The boat's stern will move toward the dock as the bow moves away. Allow for enough room or the stern will hit the dock.
- Retrieve all mooring lines and fenders.
- Proceed slowly. Sound a long blast to alert other boaters that you are departing.

When leaving a mooring, you should already have enough space around the boat to maneuver. Untie from the mooring and move back slowly until you can see it. Proceed slowly while giving the buoy wide clearance.

## Returning

### **WARNING**

**Avoid injury. DO NOT use your hands, arms or another part of your body to attempt to keep the boat from hitting the dock.**

Approach a dock slowly and use caution. Plan your maneuvers ahead of time. Allow wind and current movement to help maneuver your boat.

Be sure to read **Basic Maneuvering**, in this section.

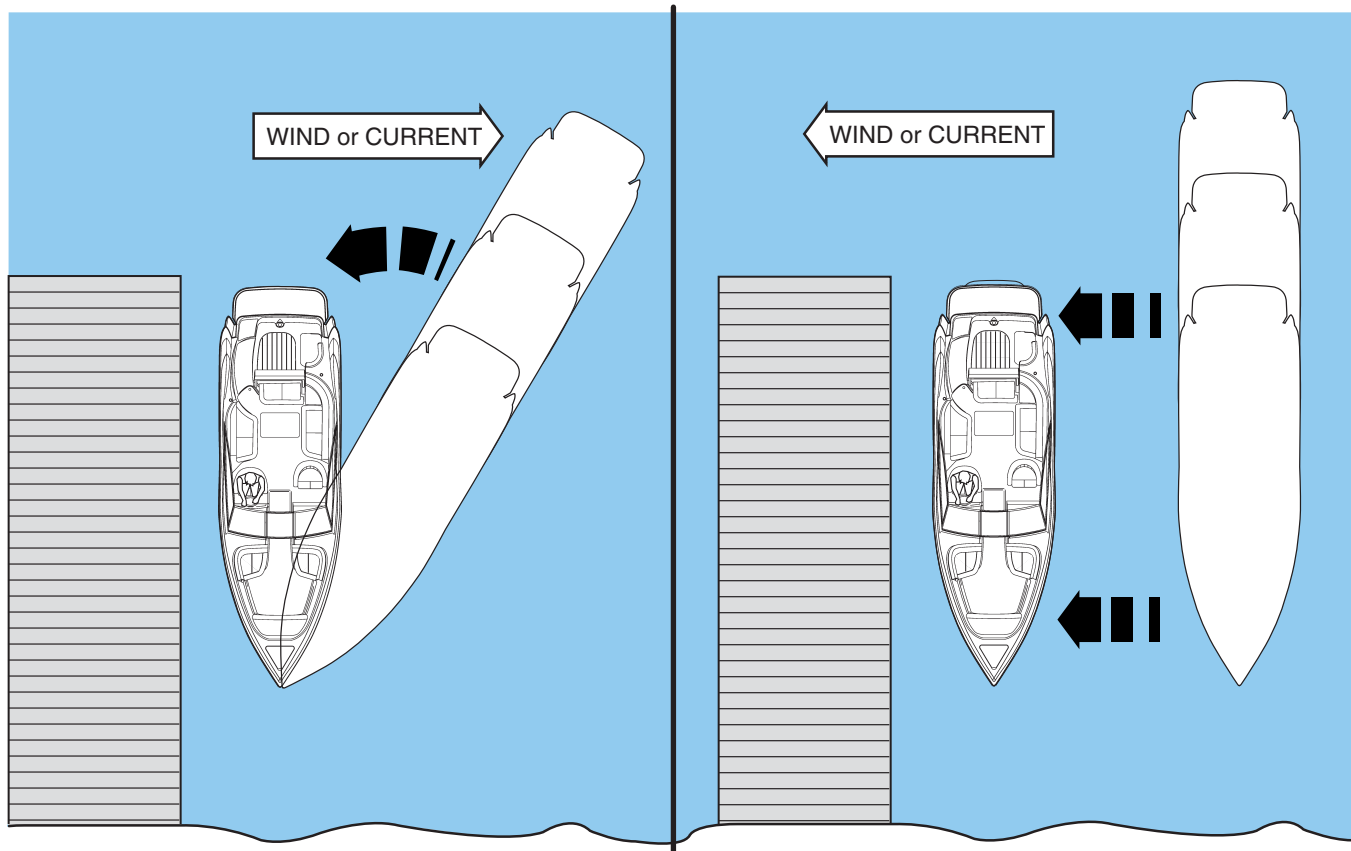

COB\_0063\_A

### Docking

Follow these guidelines when docking:

- Come to a stop a short distance from the dock, then proceed slowly.
- Have your fenders, mooring lines and the crew ready.
- Observe how the wind and current are moving your boat. Approach the dock with the boat pointed into the wind, if possible. If the wind or current is pushing you away from the dock, use a sharper angle of approach. If you must approach the dock downwind or down current, use a slow speed and shallow angle. Be ready to reverse in order to stop and maintain position.
- If there is no wind or current, approach the dock at a 10° to 20° angle.
- If possible, throw a line to a person on the dock and have that person secure a bow line. If no one is on the dock, maneuver as close as you can, then secure any line to a piling or dock cleat.
- With the bow secure, swing the stern in using engine thrust, or pull it in with a boat hook.



# OPERATING INFORMATION

## Approaching a Slip

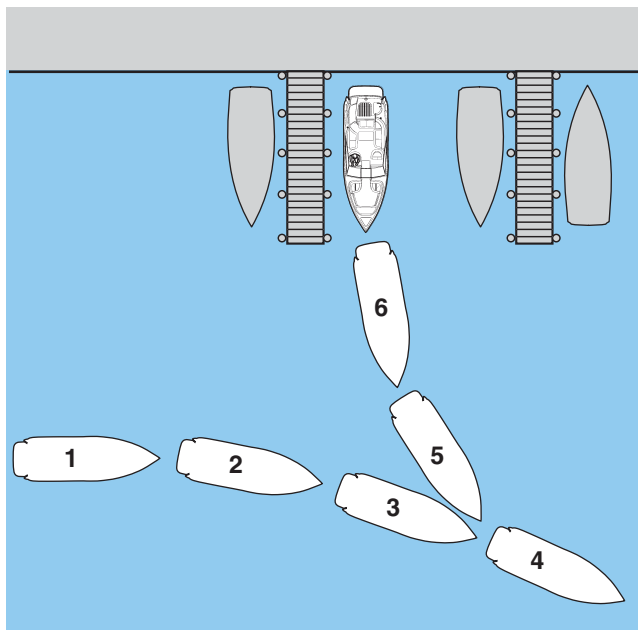

COB\_0064\_A

This maneuver is similar to backing an automobile into a garage or parking space. When approaching a slip:

- Have fenders, mooring lines and the crew ready.
- Turn the boat's stern toward the slip.
- Shift to REVERSE.
- Maneuver slowly into the slip then shift to FORWARD. Use your steering wheel and throttles to align the boat with the slip.
- Once aligned, shift to REVERSE and continue to back in slowly. Shift into FORWARD when completely in to stop the movement of the boat.
- Shift to the NEUTRAL position, secure the mooring lines and stop the engine.

## Approaching a Mooring

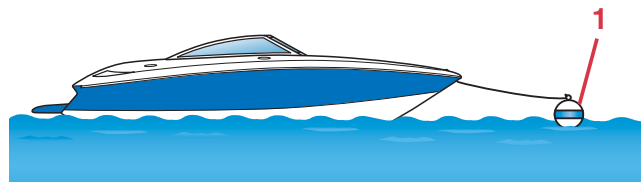

COB\_0065\_A

### 1 – Mooring Buoy

The only buoys you are permitted to moor to are mooring buoys. Mooring to a navigation buoy or other navigational aids or regulatory marker is illegal.

Approach a mooring buoy by heading into the wind or current. Observe the direction of other boats that already lie at mooring buoys. Since they are heading into the wind or current, approach your buoy at the same heading.

- When you think you can move enough forward without using your engine, shift to the NEUTRAL position.
- Have a crew member positioned on the bow with a hook to retrieve the mooring line. At that point, the crew member should be guiding your maneuvers toward the buoy.
- Turn off the engine after the mooring line is attached to the boat.

## Basic Maneuvering

### Techniques

Wandering is a characteristic of all deep V-hulls at slow speed. There is no cure for wandering; however, a very basic operational technique can be applied which will minimize this characteristic.

If the steering wheel is moved back and forth to compensate for wandering, invariably, the situation will be magnified. If the steering wheel remains in a centered position, the boat will wander back and forth slightly; however, the overall course of the boat will be a straight one.

**Trim**

Boat trim while on plane is influenced by three factors:

1. Load distribution
2. Drive unit trim
3. Trim tab position, if equipped

Determining best boat trim while underway takes time. It is best to experiment with different drive and tab trim combinations while taking note of the condition.

**Load Distribution**

The performance of your Cobalt boat depends on load weight and distribution.

Distribute weight evenly, from bow to stern, and also from port to starboard.

**Drive Unit Trim**

Trim angle is the angular relationship between the drive unit and the transom of the boat. Boat trim while underway greatly affects the performance and efficiency of your boat. For best results, the boat should be on plane and trimmed to reduce the amount of the boat's hull in the water (known as wetted surface). With less boat in the water, both speed and fuel economy increase.

Continuous trim adjustment is required when operating your boat to maintain maximum performance and efficiency.

If the drive unit is trimmed in too far (closer to the boat bottom), speed drops, fuel economy decreases and the boat may not handle correctly. However, it does provide better acceleration from a standstill; and because it forces the bow down, visibility is improved. If the drive unit is trimmed out too far (away from the boat bottom), steering torque may increase, the boat may be difficult to get on plane and it may bounce.

To use power trim effectively, start with the drive unit trimmed in. As the boat planes, increase the angle out. Experience is the best teacher for understanding proper drive trim.

# OPERATING INFORMATION

## Trim Tabs

The trim tabs, if equipped, are a separate system in themselves and are not to be used in lieu of the drive unit power trim system. Water is deflected and redirected as the trim tabs are raised and lowered. This change in the water flow creates upward pressure under the tabs, and raises the stern. When the stern raises, the bow is lowered. Likewise, lowering the port tab will cause the port stern to raise, making the starboard bow lower.

Using trim tabs in conjunction with the drive trim will compensate for uneven weight distribution, listing, water conditions and other factors that cause inefficient operation. Remember that trim tabs are trimming the hull, while power trim is trimming the drive unit.

Some systems may include indicators to show position of the tabs and drive unit.

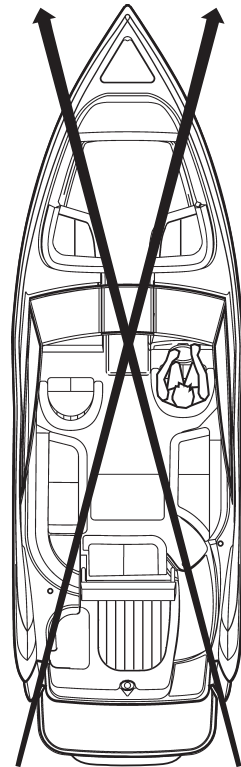

### PORT TAB LOWERED

- PORT STERN RISES
- STARBOARD BOW LOWERS

### STARBOARD TAB LOWERED

- STARBOARD STERN RISES
- PORT BOW LOWERS

COB\_0067\_A

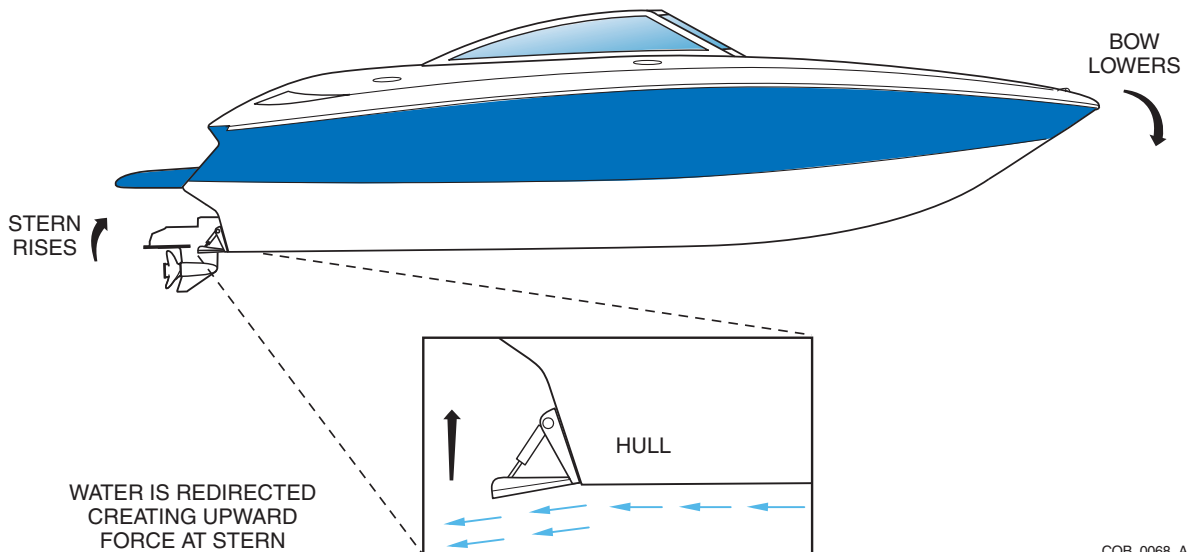

COB\_0068\_A

To adjust boat trim while underway:

1. Before accelerating, make sure both trim tabs are fully raised.
2. Adjust the trim tabs to achieve a planing attitude.
3. Use the drive trim to position the propeller path parallel to the water flow.

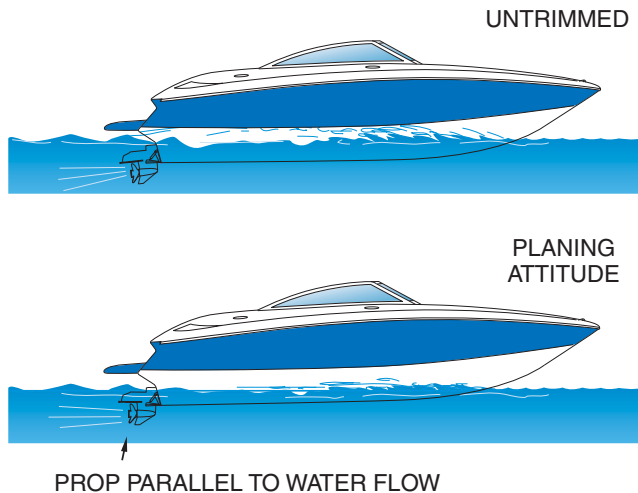

COB\_0069\_A

4. Readjust the trim tabs to fine tune attitude. Operate only one tab at a time and in small increments. As the tab takes effect, you will notice it causes the boat to veer off course slightly. Correct for this as it happens.
5. To prevent the boat from listing, do not move one tab significantly further down than the other tab.

### **⚠ DANGER**

**Avoid injury or death. Use the trim tabs slowly to adjust trim. Adjustments are not immediate. Improper use of the trim tabs at high speeds can cause an accident.**

### High-Speed Operation

#### **⚠ DANGER**

**Avoid injury, death or property damage. Maneuverability above 50 mph is limited. Sudden turns may cause loss of control. Your Cobalt boat is not designed for wake jumping. When crossing another boat's wake, throttle back to prevent your boat from leaving the water. Wake jumping is very dangerous. It is possible for the boat to re-enter the water on its side, transom or bow. You and your passengers could suffer serious injury. Also, damage to the boat could take place causing a hazardous condition.**

When operating any boat at high speed, exercise a great deal of caution. This is particularly true during turns. Gradual turns can be completed at high speed by a competent driver, but it must be emphasized that sudden turns at any speed, and particularly at high speed, can be especially dangerous. It is possible to throw passengers from their seats and even from the boat if caution is not exercised. Remember, common sense is the rule for safe boating.

We recommend that you have 10 hours of experience with the boat before any full throttle operation. Do not operate your boat until you are completely experienced with its handling characteristics. The following are some guidelines for performance operation.

- Keep bottom of the hull clean and free of barnacles and other growth. Growth on the hull can slow the boat down considerably.
- Prepare the boat. Be sure all gear is properly stowed and compartments are latched.
- Weight distribution affects performance. Keep weight in the boat to a minimum and evenly distributed.

# OPERATING INFORMATION

- The propellers should be of the proper pitch to turn the recommended RPM rating for the engine with an average boat load. Refer to your propulsion unit operator's manual for additional information.
- Watch the tachometer. Keep the engine within the full throttle operating range. Refer to the propulsion unit operator's manual for full throttle operating range.

**⚠ DANGER**

**Avoid injury, death or loss of control. Do not make aggressive turns at high speed. Keep one hand on the steering wheel and the other on the throttle control at all times. If the boat begins to operate in an unsafe way, pull back on the throttle. Trim the drive unit in at the same time and maintain control.**

High-speed operation requires quick reactions and adjustments are needed to maintain control. Know your limits and stay within them. Keep one hand on the steering wheel and the other on the throttle; constant adjustments are necessary for rapidly changing conditions. Small inputs of throttle, steering and trim movement are exaggerated at high speeds. Keep watch well ahead so that you have enough time to react.

## Anchoring

**⚠ WARNING**

**Avoid injury, death or swamping. Anchor from the bow, not from the stern. A strong current can pull a boat underwater, anchored by the stern, and keep it there.**

Be sure the anchor is adequate for your boat. Use caution when anchoring. Look for signs of underwater pipes or cables. With the engine off, you have no control of the boat. Water and wind conditions will affect an anchored boat. Be sure the anchor will hold before leaving the boat.

There are many types of anchors available on the market. The choice of one anchor over another depends on many factors. An anchor will usually hold best in a mixture of mud and clay or in hard sand. A Danforth anchor is recommended for general boating. For more information on anchors, contact your authorized Cobalt dealer.

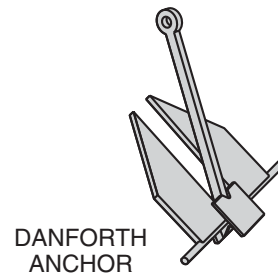

KC-1571

The windlass, if equipped, gets its power from the 12V DC system. The windlass can be operated at the driver's helm or from the foredeck on some models and only from a switch located in the anchor locker area on others.

On some models, the windlass system can also be operated manually. On the anchor locker lid on the foredeck, you will find a crank. A longer windlass crank is located in one of the cockpit storage areas or in the engine compartment bulkhead.

Please consult the operator's manual supplied with the windlass system for proper operation of the system in the electric and manual modes.

The circuit breaker on the battery switch panel under the port aft seat must be in the ON position to operate the windlass. When not in use, turn the circuit breaker to the OFF position.

### **WARNING**

#### **Avoid injury and/or property damage.**

- **Keep hands, feet, loose clothing and hair well clear of the winch and rope/chain during operation.**
- **Keep clear view of the winch, rope, chain and anchor when operating the winch. This may require a second person when operating.**
- **Run the boat's engine while raising or lowering the anchor. Not only is this a safety precaution, it also prevents draining of the batteries.**
- **DO NOT use the winch as a bollard. When anchored, secure the anchor line directly to a bollard or deck cleat.**
- **Secure the anchor with a rope or fastener pin when operating the boat at high speed, in heavy weather or while transporting.**
- **Turn the WINDLASS switch off when the winch is not in use and before leaving the boat.**
- **Keep the rope in good condition and free from twists, knots, heavy abrasions and salt buildup. In the event of the rope slipping or jamming, reverse the direction of the winch and check the rope for damage.**
- **Ensure the size and type of chain used with this switch is compatible with the rope/chain.**

Use caution when anchoring. Look for signs of underwater pipes or cables. With the engine off, you have no control of the boat. Water and wind conditions will affect an anchored boat. Be sure the anchor will hold.

#### **Lowering**

Bring the boat to a stop with the bow facing into the wind or current. Lower the anchor. On dash control, place safety switch in the ON position.

Press and hold the toggle switch down to pay out sufficient rope/chain to set the anchor.

#### **Setting**

When the anchor hits bottom, slowly back up the boat, keeping tension on the line. The anchor line should be five to seven times the depth of the water.

#### **Weighing (May require two persons)**

To weigh (retrieve) the anchor, start the engine and slowly move forward. Press the toggle switch up while taking in anchor line as you go. Carefully retrieve the last meter (36 inches) of rope/chain, then seat the anchor in the bow fitting.

The anchor must be secured with anchor snubber (clip, shackle, etc. with short piece of line) when it is stored to prevent accidental deployment. When anchor is deployed and in use, the rode (rope or chain) must be secured to a cleat or secure holding point. Do not use windlass to hold vessel.

Refer to the windlass operator's instructions for additional operating information, if equipped.

#### **Towing**

If seas are rough, it may not be easy to extend the tow line from one boat to another. In these cases, use a light throwing line with a weight on one end and with the heavier towing line secured to it.

Do not attempt to tow a larger or grounded vessel.

Because of the tremendous stress caused by towing, use a tow line that is rated at least four times the gross weight of the boat being towed.

Tow ropes must be in good condition, free of any cuts or abrasions.

Attach the tow line (2) to the bow eye (3) on the disabled boat. Attach the opposite end of the bridle only to the stern cleats (1) of the tow boat. Wrap the bridle with chafing gear where it rubs against the boat.

Leave at least two boat lengths between the boats for adequate movement.

### **DANGER**

**Avoid injury, death or property damage. When towing, only use the bow eye and stern eyes. DO NOT use deck cleats or handrails. DO NOT allow anyone to be in line with the tow rope.**

# OPERATING INFORMATION

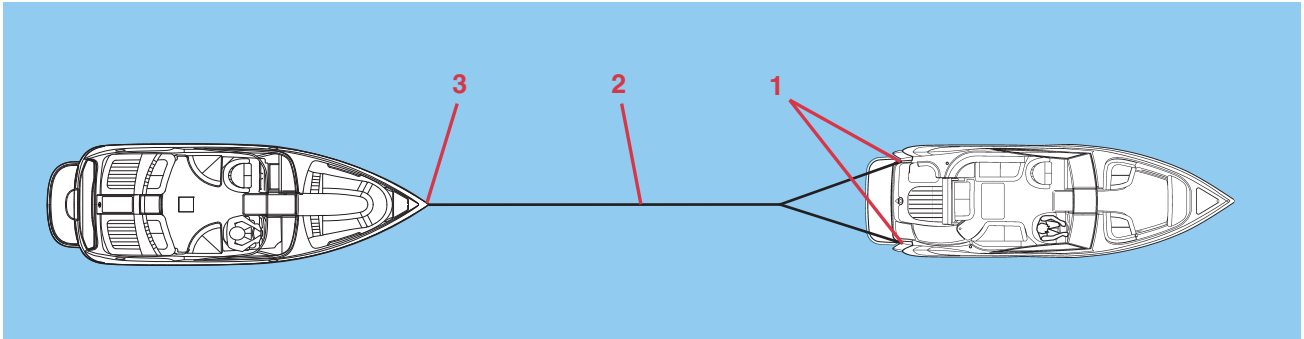

COB\_0003\_A

Adjust the tow line to match wave action. Keep the boats on the crest or in the trough of the waves at the same time. In protected, calm waters, shorten the line for better handling. Tow at moderate speed, allowing for adverse wind and wave conditions. Have the operator of the towed boat steer with you, if possible.

If you need a tow, or wish to tow another boat, use great care. The boat structure can be damaged by excessive pulling strain. You should offer help to a boat in trouble. However, towing a capsized, grounded or hull-damaged boat is dangerous. Give assistance to the occupants, then call the proper authorities.

## Environmental Considerations

Using your boat in different environments requires special operating considerations.

### Salt Water

During long periods of mooring, if possible, tilt the propulsion unit drives out of the water – except in freezing temperatures. Refer to the drive system owner's manual for more information on saltwater operation and protection.

Freshwater flushing of the engine is recommended after operating in salt, polluted or brackish water. Refer to your engine operator's manual for additional information.

### Freezing Temperatures

When boating in temperatures below freezing, keep the propulsion unit drives tilted down (submerged) at all times. This will help prevent damage from freezing.

Upon removing your Cobalt boat from the water, leave the drive unit in the vertical position until cooling system has drained.

Refer to your propulsion unit operator's manual for additional information regarding winterization.

### Entertainment System

To operate your entertainment system, you must first supply power to the unit(s). Make sure the battery switch is on. If your boat is equipped with a Power Distribution Panel, the switches for the entertainment system components must be turned to ON before operation. For additional operating information, refer to the operator's manual for your stereo and accessories supplied to you in your owner's packet. For a list of what is standard, or is available for your entertainment system, refer to **Standard and Optional Equipment** in this section.

The audio speakers in your Cobalt are designed to deliver maximum fidelity in a marine environment. The speakers can be damaged if struck by a sharp object or if the moving elements are restricted from movement. Do not store or place any sharp objects near the speakers, or restrict the element movement.



# OPERATING INFORMATION

## HELM AND INSTRUMENTATION

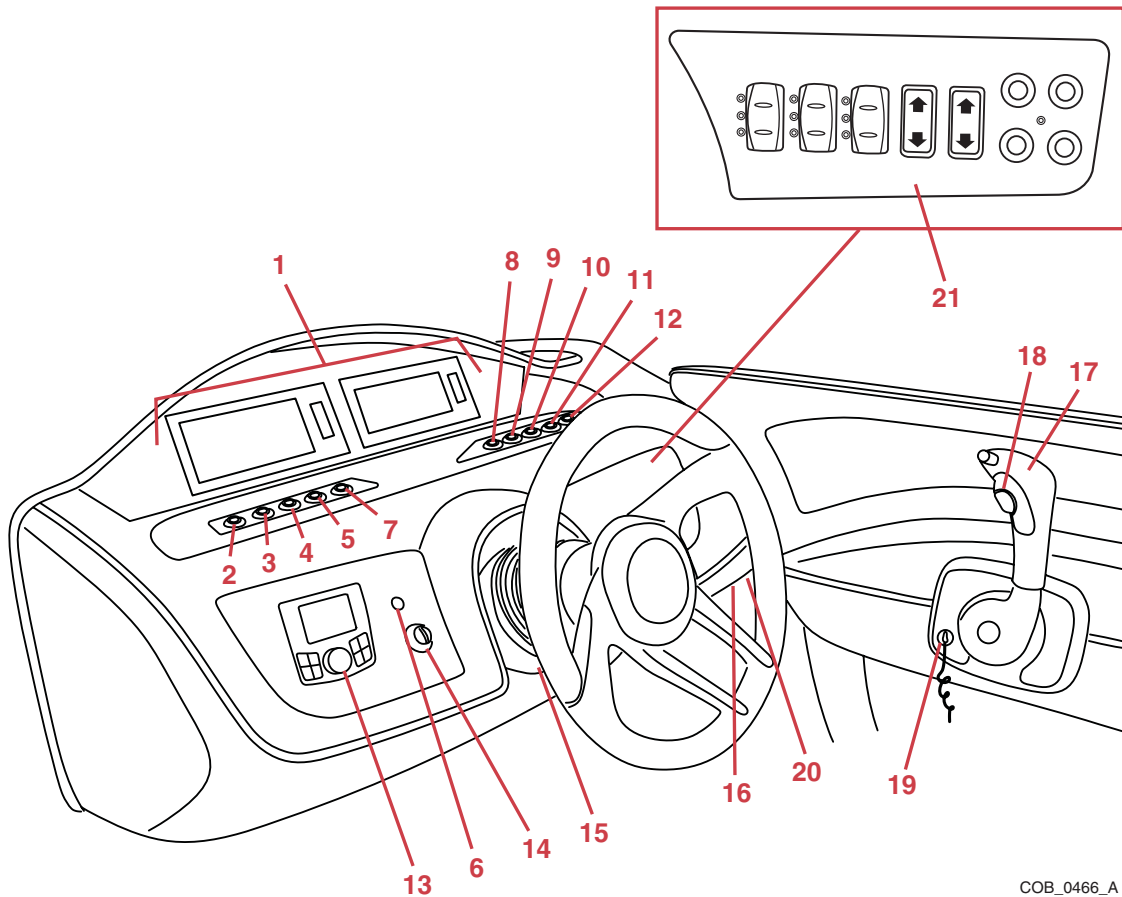

COB\_0466\_A

Your Cobalt boat helm will monitor and provide operation of the boat's functions. The gauges are illuminated for night operation.

On occasion, a small fluctuation in a gauge reading is not unusual. If an instrument reading is outside the normal or recommended ranges, determine the cause or see your authorized Cobalt dealer.

Refer to the engine operator's manual for normal recommended ranges.

### **WARNING**

**Avoid the risk of injury, death or equipment damage. If the safety of you or others depends on running the engine during an abnormal condition, make the right decision on saving equipment or lives. Do not jeopardize the safety of you or others to protect your boat.**

## 1. GLASS COCKPIT DASH UNIT

Smart Mode screens are preprogrammed by Cobalt. To access screens:

1. Press HOME, if not already there.
2. Press Smart Mode.
3. Select desired mode from Smart Mode screen.



**NOTICE: To reset to default settings, contact your Cobalt dealer.**

A/V, Gauges/Control settings are auto-populated, depending on options; however, they can be customized.

To adjust screen brightness, press and release power button quickly.

If your boat is equipped with EVC, when the engine is turned off, turn the key back to the ON position within 2 seconds. The screens will stay on. From Power Off, it takes approximately 60 seconds for displays to boot up.

If your boat is equipped with EVC, the functions on page 2 of the engine data will not populate without the Volvo trip computer option.

For more detailed information, you can review your owner manual on the screen under Info or the Garmin Quick Start Manual in your boat bag. You can also go to [garmin.com](http://garmin.com) under Marine Device Software Updates for the latest software updates, if desired.

**2. BILGE BLOWER** - This switch activates the engine compartment ventilation blower to remove explosive fumes from the area. The blower must be operated for a minimum of four minutes each time before starting the engine. In addition, the blower should be operated continuously when at idle or running at slow speeds. The LED will illuminate if the switch is ON.

**3. BILGE PUMP** - This switch manually controls the bilge pump.

**4. INTERIOR LIGHTS** - This switch provides illumination within the cockpit area.

**5. DOCKING LIGHTS (Optional)** - This switch operates the docking lights.

Docking lights are to be used for docking only. It is illegal to use your docking lights while cruising.

**6. HORN** - This switch activates the horn. Press the switch to activate.

**7. CAPTAIN'S CALL (Optional)** - This switch determines the routing of the engine exhaust. In the ON position, engine exhaust is routed through the thru-hull pipes. This position produces the most engine power, but is not acceptable near shore or on inland lakes and rivers.

In the OFF position, engine exhaust is routed through the hub of the propeller. This position releases the exhaust underwater, providing a quieter engine sound.

Be sure to check local regulations regarding noise restrictions before operating this system.

### CAUTION

**Avoid damage to the exhaust system. DO NOT switch the routing of the exhaust above 3,000 RPM.**

**8. UNDERWATER LIGHTS** - This switch provides illumination of the underwater lighting.

**9. PLATFORM LIGHTS** - This switch provides illumination within the platform area.



**NOTICE: Operate the boat between sunset and sunrise using your navigational lights. Navigational lights are legally required to indicate direction and right-of-way at night.**

**10. ANCHOR / MOORING LIGHT** - All boats at anchor or moored must display a proper white anchor light.

The anchor light (all-around light) is the white light that is installed into a receiver located aft of the cockpit. The anchor light must be visible from 360° and will remain on when operating the navigational lights.

# OPERATING INFORMATION

**11. NAVIGATION LIGHTS - For Inland Rules only. Do not use in international waters.** You must use your navigation lights and anchor/mooring light when operating your Cobalt boat between sunset and sunrise, and when daytime visibility is limited. Check with your local authorities for other requirements concerning the use of navigation lights before operating your boat.

The navigation lights are identified by a red light on the port side of the vessel and a green light on the starboard side.

**12. ACC** - This switch is available to operate switched accessory items.



**NOTICE: DO NOT connect an accessory drawing more than 10 amps to the accessory switch. A hazardous situation or damage to the electrical system can occur.**

**13. STEREO REMOTE CONTROL (standard on dash, transom mount – optional)** - This panel provides remote control of the stereo system from the helm.

**14. IGNITION SWITCH** - This switch starts the engine. It also supplies accessory power when turned to the left.

## **WARNING**

**Avoid injury, death or explosion.**

- **Check engine compartment for gasoline or vapors.**
- **Operate blower for four minutes.**
- **Verify blower operation.**
- **Run blower below cruising speed.**

**15. TILT STEERING RELEASE LEVER** - This lever adjusts the steering wheel angle to a comfortable position when the boat is not moving.

## **16. 12-VOLT ACCESSORY POWER**

**RECEPTACLE** - Your Cobalt boat is equipped with one 12V USB port at the dash (this replaces the round 12V receptacle) and one 12V USB port in the port side bow (located next to the port bow speaker and drink holders). Please note that these USB ports are for charging only; they are not connected to the stereo. Only the USB port at the glove box is connected to the stereo.

**17. SHIFT/THROTTLE LEVER** - Your control is a single lever which operates as both a gear shifter and a throttle. The control has a detent to position NEUTRAL for starting.

To shift, move the lever to FORWARD or pull it back for REVERSE. Advancing the lever beyond the shift position increases engine RPM. DO NOT shift when the engine is not running. Refer to the engine operator's manual for more information and functions of the remote control.

**18. DRIVE UNIT TRIM SWITCH** - This switch controls the trim angle of the drive unit and will maximize the performance and ride of the boat. If combined with the optional trim tabs, enhancement to your performance and ride can be achieved.

### 19. IGNITION SAFETY SWITCH

#### **⚠ WARNING**

**Avoid injury, death or damage to equipment. Do not allow your boat to be operated without the proper use of the ignition safety switch and lanyard.**

Your Cobalt boat is equipped with an ignition safety switch located on the lower lip of the helm. The ignition safety switch and lanyard will stop the engine in case of an emergency. Attach the lanyard to the boat operator whenever the engine is running, but be aware there will be a loss of boat control if the switch is activated. If the operator is thrown from the seat or moves too far from the helm, the lanyard will become disconnected from the ignition safety switch, shutting off the engine.

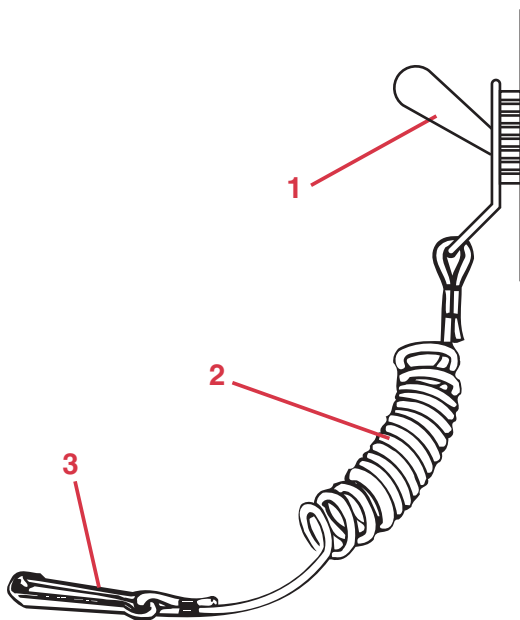

COB\_0042\_A

- 1 – Ignition Safety Switch
- 2 – Lanyard
- 3 – Hook

#### **⚠ DANGER**

**Avoid injury or death. Attach the ignition safety switch lanyard to the operator before starting the engine. This will prevent the boat from becoming a runaway if the operator is accidentally thrown away from the helm. The ignition safety switch can only be effective when it is in good working condition. Observe the following:**

- **Do not remove or modify the ignition safety switch and/or lanyard.**
- **The lanyard must be free from obstructions that could interfere with its operation.**
- **DO NOT operate the boat if the ignition safety switch does not function properly.**
- **Attach the ignition safety switch lanyard to a secure place on your clothing, your arm or leg while operating.**
- **DO NOT attach the lanyard to clothing that could tear loose. DO NOT route the lanyard where it could become entangled, preventing it from functioning.**
- **Avoid accidentally pulling the lanyard during normal operation. Loss of engine power means loss of most steering control. Also, without engine power, the boat could slow rapidly. This could cause occupants and objects in the boat to be thrown forward.**

# OPERATING INFORMATION

## Remote Control

### DANGER

**Avoid injury or death. Make sure all shift/throttle hardware and cables are regularly inspected and maintained. Improperly maintained controls are hazardous and may cause sudden loss of control.**



**NOTICE: Do not use the shift levers when the engines are not running. Do not shift too quickly from FORWARD to REVERSE. Damage to the engine and transmission can result. When shifting from FORWARD to REVERSE, pause in the NEUTRAL position until the engine is at idle speed and the boat has slowed. When shifting from NEUTRAL to FORWARD or REVERSE, shift briskly and decisively.**

Your Cobalt boat is equipped with a safety switch for “start-in neutral-only” operation. The shift lever must be in the NEUTRAL position before attempting to start the engine.

The following information relates to the general description of your controls. Refer to the engine operator’s manual or the control operator’s manual for specific use.

### **20. ACCENT LIGHT SWITCH AND DIMMER - OPTIONAL**

It is the operator’s responsibility to know and comply with local laws. Although not universally regulated, some color lights may not be compliant with certain local ordinances. Please know your local marine lighting regulations before use.

**CIRCUIT BREAKERS** - There are breakers for the helm labeled protected devices located in the starboard bow storage compartment. These breakers will activate if overloaded, and cut power to the switch. To restore power, turn off the device, push the breaker button in and release. If the button continues to pop out when the device is used, see your authorized Cobalt dealer. Your boat may not be equipped with all of these features or options.

**ENGINE HATCH** - This switch operates the electric motor box assembly. Do not continue to operate the switch when the motor box is closed or fully open. Lower the motor box support after the motor box is opened. Be sure to return the support to its stowed position before lowering the box.

The motor box switch is located inside of the starboard gunwale opposite the motorbox.

**REMOTE COURTESY LIGHTS w/KEY FOB - OPTIONAL** - The courtesy lights can be controlled by using an optional remote control light switch, contained on a key fob for your convenience. One remote control light switch button allows you to control the lights within the cockpit and the other switch button controls the lights at the swim platform.

**WATER PRESSURE - OPTIONAL** - This switch activates the water pressure pump. Water pressure is required for the transom shower.

## **21. WAKE SURF CONTROLS**

### **Functions that are performed in any mode:**

At 14 miles per hour, surf tabs will fully retract and down operation will be disabled until speed drops back below 8 miles per hour.

If communication with GPS speed is lost, the **SURF LEFT** and **SURF RIGHT** lights will flash. System will act as if boat is over 14 miles per hour until GPS speed communication is re-established. This will happen if GPS signal is blocked by items such as roofs or buildings.

If communication with engine is lost, the **Performance** and **Trailer/Hoist** lights will flash. Performance, SURF RIGHT, and SURF LEFT will be disabled.

If there is an overcurrent or if the controller detects a failure in the control of the Surf Tabs, the **Check Surf System** indicator light will flash. If this happens, proceed with caution as the wake surf tabs are in an unknown position and can cause excessive boat angles at speeds over 14 mph.

System can be reset by cycling ignition key to the OFF position, waiting for boat to power down, and then keying back ON.

#### **Manual Mode:**

The system always powers up in Manual mode. If no other mode is active, the system will be in Manual mode.

In this mode, there is no automatic movement other than the 14 mile per hour threshold that will cause the tabs to retract.

When in Manual mode, the indicator light will flash anytime the surf tabs are moving.

#### **Ballast Tank Operation:**

Open all seacocks. (There are two or three depending on the model.) To fill the ballast tanks with water, select the corresponding tank switch to "FILL." The pump will automatically shut off when tank is full. The pump will run, after full float is activated, for an extended amount of time depending on tank.

If you want to add more water to the tank, after the pump has shut off, you can cycle the switch to the "OFF" position and then back to "FILL." The pump will run for an extended time and then automatically turn off.

To empty ballast tanks, move the corresponding switch to the "EMPTY" position. The pump will automatically shut off when tank is empty. If pump can be heard sucking air and pump is still running, the empty float may need to be adjusted. If you want to remove more water from the tank, you can cycle the switch to "OFF" position and then back to "EMPTY" position. The pump will run for an extended time and then automatically turn off.

If the switches are left in the "FULL" position, once the tanks indicate full, the pumps will be shut off until a new command is given. If the switches are left in the "EMPTY" position, they will automatically come on again, if the float indicators indicate the need. You can turn off the pumps at any point by moving the switches to the "OFF" position.

There is a FULL, 1/2, and 1/8 LED indicator for each tank. The tank is empty when the 1/8 indicator light turns off.

#### **Surf Tab Operation:**

The left surf tab switch controls the PORT surf tab and the right surf tab switch controls the STBD surf tab.

By pushing the switch in the "DOWN" position, the corresponding surf tab will extend.

By pushing the switch in the "UP" position, the corresponding surf tab will retract.

#### **Wake Surf Operation:**

##### **Surf Left:**

Operator presses and releases the "SURF LEFT" momentary switch. The system enters SURF LEFT mode, if GPS speed is less than 8 miles per hour. SURF LEFT indicator light blinks while surf tabs and engine trim are being commanded to move. After surf tabs and engine trim have stopped moving, SURF LEFT indicator light comes on solid until next movement is commanded. SURF LEFT mode stays active until the SURF LEFT button is pressed again or another mode is selected. The following sequence is initialized:

- SURF LEFT indicator light begins flashing.
- Right surf tab goes down.
- Left surf tab rises. This will fully retract the left surf tab.
- Outdrive trim goes to surf position.
- SURF LEFT indicator light becomes solid until new mode is selected or further movement of the surf tabs or engine trim are commanded.
- Once GPS speed reaches 14 miles per hour, both surf tabs are commanded fully up.
- Once GPS speed drops below 8 miles per hour, system re-initiates, placing surf tab and engine trim back into SURF LEFT position.

# OPERATING INFORMATION

- SURF LEFT pushed a second time will cause both surf tabs to fully retract. At this point it will be in Manual mode.

## Surf Right:

Operator presses and releases the “SURF RIGHT” momentary switch. The system enters SURF RIGHT mode if GPS speed is less than 8 miles per hour. SURF RIGHT indicator light blinks while surf tabs and engine trim are being commanded to move. After surf tabs and engine trim have stopped moving, SURF RIGHT indicator light comes on solid until next movement is commanded. SURF RIGHT mode stays active until the SURF RIGHT button is pressed again or another mode is selected. The following sequence is initialized:

- SURF RIGHT indicator light begins flashing.
- Left surf tab goes down.
- Right surf tab rises. This will fully retract the left surf tab.
- Outdrive trim goes to surf position.
- SURF RIGHT indicator light becomes solid until new mode is selected or further movement of the surf tabs or engine trim are commanded.
- Once GPS speed reaches 14 miles per hour, both surf tabs are commanded fully up.
- Once GPS speed drops below 8 miles per hour, system re-initiates, placing surf tab and engine trim back into SURF RIGHT position.
- SURF RIGHT pushed a second time will cause both surf tabs to fully retract. At this point it will be in Manual mode.

## Performance Mode:

Operator presses and releases the “Performance” momentary switch. The system enters Performance mode. Performance indicator light blinks while surf tabs and engine trim are being commanded to move. After surf tabs and engine trim have stopped moving, Performance indicator light comes on solid until next movement is commanded. Performance mode stays active until the Performance button is pressed again or another mode is selected. The following sequence is initialized:

1. Outdrive trim is commanded all the way down.  
If all three ballast tanks are empty:
2. Surf tabs will fully retract.

3. When speed reaches 14 miles per hour, surf tabs will fully retract.
4. When speed drops below 8 miles per hour, system will reset to step 1.

If any of the ballast tanks contain water:

5. If speed is below 8 miles per hour, surf tabs will fully extend.
6. When speed reaches 10 miles per hour, surf tabs will partially retract.
7. When speed reaches 14 miles per hour, surf tabs will fully retract.
8. When speed drops below 8 miles per hour, system will reset to step 1.

## Trailer/Hoist Mode:

Operator presses and releases the “Trailer/Hoist” momentary switch. The system enters Trailer/Hoist mode. Trailer/Hoist indicator light blinks while surf tabs are being commanded to move. After surf tabs have stopped moving, Trailer/Hoist indicator lights come on solid until next movement is commanded. Trailer/Hoist mode stays active until the Trailer/Hoist button is pressed again or another mode is selected. The following sequence is initialized:

1. Both left and right surf tabs are fully retracted and down movement is disabled.
2. All three ballast tanks are emptied. Ballast switches are disabled while in this mode. Pumps will automatically turn off when tanks are emptied. If pump can be heard sucking air and pump is still running, empty float may need to be adjusted.



**NOTICE: When using surf system, turn off power trim assist (PTA) located on control lever. PTA may cause undesired surf system operation.**

## STANDARD AND OPTIONAL EQUIPMENT

FEATURES	R3		R3 Surf		R3 WSS	
	Standard	Optional	Standard	Optional	Standard	Optional
<b>Canvas</b>						
Bimini, Premium		X				
Bimini, Premium Easy-Fold		X				
Bow Tonneau Cover		X		X		X
Cockpit Tonneau Cover		X		X		X
Mooring Cover		X		X		X
<b>Dash</b>						
Accessory Power Plug - 12 Volt	X		X		X	
Black Leather/SS Steering Wheel	X		X		X	
Color-Matched Aluminum Dash Panels	X		X		X	
Compass, Digital	X		X		X	
Composite Helm Eyebrow, Custom Stitching	X		X		X	
Dash Perimeter SS Accent Trim	X		X		X	
Depth & Water/Air Temp Gauge Pkg	X		X		X	
Easy-Surf Electronic Control System			X			
Glass Cockpit, Dual Garmin 7607	X				X	
Glass Cockpit, Garmin 7607			X			
Gloss Black Dash Console w/SS Accents	X		X		X	
Hour Meter	X		X		X	
Illuminated Switch Panel/Switches	X		X		X	
Makassar Dash/Interior Trim Pkg.		X		X		X
Rudder Indicator, Merc		X				X
Rudder Indicator, Volvo		X		X		X
Stainless Steel Switches	X		X		X	
XM Weather		X		X		X
<b>Exterior</b>						
Anchor Locker	X		X		X	
Arch, Alum, Folding w/Bimini		X		X		X
Arch, Electric, Alum Folding w/Bimini		X		X		X
Arch, Folding w/Rotating Sunshade		X				
Arch, SS/Alum w/Sunshade		X		X		X
Bow Scuff Plate, Stainless Steel	X		X		X	
COBALT Oval Logo, Recessed		X				
Docking Lights-Stainless Steel		X		X		X
Extended Running Surface	X		X		X	



# OPERATING INFORMATION

FEATURES	R3		R3 Surf		R3 WSS	
	Standard	Optional	Standard	Optional	Standard	Optional
Fender Clips w/Line (4)	X		X		X	
Flagpole w/Flag		X				
Graphics, Molded-In Gelcoat	X		X		X	
Midship Cleats	X		X		X	
Motorbox Actuator		X		X		X
Ski Pylon - Stainless Steel	X				X	
Ski Pylon (arch mounted)			X			
Sof-Trac Marine Mat, Swim Platform		X				
Sof-Trac Mat, Flip-Down Swim Step				X		X
SS Tubular Platform Perimeter Rail	X		X		X	
Stainless Steel Engine Vents	X		X		X	
Stainless Top Trim Windshield	X		X		X	
Surf Tow Ball (2)-Folding Arch only				X		
Swim Platform Transom Lighting		X		X		X
Swim Platform w/Flip-Down Swim Step	X		X		X	
Transhield Shipping Cover		X		X		X
Transom Shower		X		X		X
Transom Tilt Switch		X		X		X
Umbrella w/Receiver (ski pylon mounted)		X		X		X
Underwater Lighting		X		X		X
Wakeboard Racks, Elite (Alum)		X	X		X	
Wakeboard Racks, Triton		X		X		X
<b>Interior</b>						
Aft Facing Rumble Seat	X		X		X	
Aft Sunpad Backrest SS Accent Rail	X		X		X	
Aft Walk-Thru Carpet	X		X		X	
Air Compressor w/Holder		X		X		X
Bow Armrests	X		X		X	
Bow Center Cushion Insert		X		X		X
Bow Walk-Thru Doors	X		X		X	
Captain's Chair, Power		X		X		X
Carpet, 40 oz., Snap-In w/Neoprene Back	X		X		X	
Del Mar Helm Capt. Chair	X		X		X	
Dinette Table w/CP & Sunpad Receptacle		X		X		X
Floor Covering, Sea Grass		X		X		X

FEATURES	R3		R3 Surf		R3 WSS	
	Standard	Optional	Standard	Optional	Standard	Optional
LED Interior Accent Lighting (RGB)		X		X		X
Passenger Seat Flip Backrest System	X		X		X	
Quilted Pattern Upholstery Accents		X		X		X
Remote Courtesy Lights w/Key Fob		X		X		X
Removable Bow & Cockpit Carpet	X		X		X	
Seating Varadense Comfort	X		X		X	
Sof-Trac Marine Mat, Cockpit		X		X		X
Stainless Steel Foot Tread (helm only)		X		X		X
Sundeck Convertible Lounger	X		X		X	
Sunpad Filler Cushion (w/Dinette)		X		X		X
Sunpad Filler Cushion (w/o Dinette)		X		X		X
Throw Pillows, Weighted (10)		X		X		X
Throw Pillows, Weighted (4)		X		X		X
Trash Receptacle, Cockpit	X		X		X	
<b>Stereo</b>						
Custom Acoustic Speaker Covers	X		X		X	
iPod/USB/MP3 Port	X		X		X	
Platinum Sound w/Transom & Arch Speakers-2pr.		X		X		X
Platinum Sound w/Transom Speakers		X		X		X
Premium Sound w/Transom & Arch Speakers-1pr.		X		X		X
Premium Sound w/Transom Speakers		X		X		X
Satellite Radio System		X		X		X
Sound System, Bluetooth, w/6 Spkrs.	X		X		X	
Stereo Remote, Dash	X		X		X	
Stereo Remote, Transom (Premium Sound)	X		X		X	
Stereo Remote, Transom (Standard Sound)		X		X		X
<b>Structure</b>						
10/5/3 Year Warranty Protection	X		X		X	
Battery Maintainer/Charger, 110V		X		X		X
Battery Maintainer/Charger, 220V		X		X		X
Battery Switch, Dual w/ACR		X				X
Battery Switch, Dual w/ACR (required)				X		
Battery Switch, Single	X		X		X	
Captain's Call Exhaust		X				X
Captain's Call Plus (w/Mufflers)		X				X

# OPERATING INFORMATION

FEATURES	R3		R3 Surf		R3 WSS	
	Standard	Optional	Standard	Optional	Standard	Optional
CE Requirements w/Automatic Fire Extinguisher		X		X		X
Circuit Breaker Protected Elec System	X		X		X	
Composite Floor	X		X		X	
Composite Transom	X		X		X	
Cruise Control-Smart Tow (Merc DTS)		X				X
Cruise Control-Zero Off			X			
Cruise Control-Zero Off (Vol EVC)		X				X
Driver's Rearview Mirror (W/S Mount)		X		X		X
Fiberglass Cockpit Liner	X		X		X	
Fiberglass Stringer System	X		X		X	
Fire Extinguisher, Automatic System		X		X		X
Fire Extinguisher, Manual	X		X		X	
Ignition Safety Switch	X		X		X	
Kevlar™ Reinforced Hull	X		X		X	
Rigid Multi-Tank Ballast System			X			
Single-Axis Performance Surf Tab System			X			
Stainless Steel Windshield Braces	X		X		X	
Through Prop Exhaust	X		X		X	
Tool Kit		X		X		X
Trim Tabs w/Indicators		X				X
Windlass, All Chain w/Anchor		X		X		X

### CAPTAIN'S CHAIR ADJUSTMENTS AND OPERATION

Your captain's chairs have the flip-up position for greater visibility and maneuverability while docking. You can sit on the raised cushion or stand in front of the cushion.

Standing while driving your boat should only be done while maneuvering at an idle by an experienced driver.

The chairs are adjustable fore and aft and also rotate. Some fore and aft adjustment may be necessary when swiveling your seat(s) to avoid damage to the chair or side panel. Some seating configurations do not allow all seats to rotate completely.

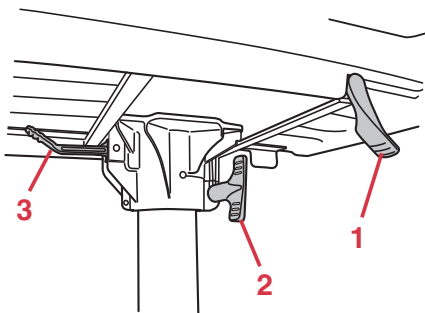

COB\_0093\_A

1. Lift lever to adjust fore and aft.
2. Turn rotation friction handle clockwise to increase friction and counterclockwise to decrease friction. The chair should always be operated with slight friction.
3. Rotation lever for chair - move chair slightly forward, then lift lever to rotate. The lever will rest in its detent when the seat is in its forward direction.

### HELM SEAT ELECTRIC SLIDE OPERATION (OPTIONAL)

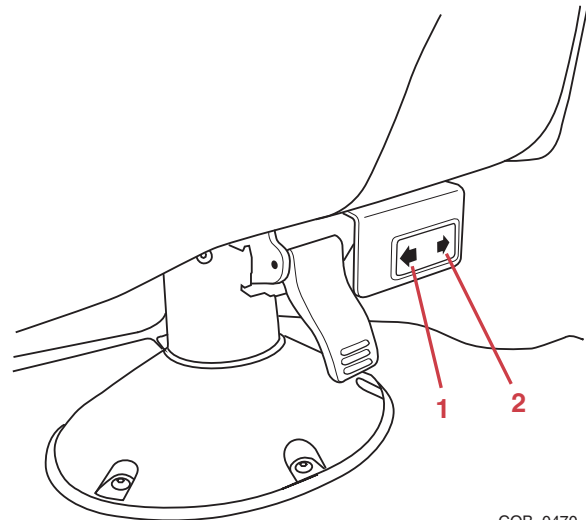

COB\_0470\_A

#### Helm Seat With the Electric Slide Operation

1. Press and hold down the rocker switch in the forward position (1) to move the helm seat forward.
2. Press and hold down the rocker switch in the aft position (2) to move the helm seat aft.

#### **⚠ DANGER**

**Avoid potential injury or ejection of occupants. DO NOT stand while driving above engine idle speeds and make sure all passengers are seated and seats are in a locked/secured position when the boat is underway.**

# OPERATING INFORMATION

## FLIP DOWN SWIM STEP

### Boat in the Water

First, lower the drive all the way.

#### To deploy the step:

1. Kneel down to reach the plunger; pull the plunger out and pull up on the step at the same time.
2. Push the step over into the water. The step will be buoyant.
3. Sit on the platform and push the step down with your feet; it will automatically lock into place.

#### To raise the step:

1. Push down slightly on the step with your feet while sitting on the platform.
2. Pull the plunger and allow the step to float up.
3. Move to the side and pull the step onto the platform. It will automatically lock into place.

### Boat on a Trailer

Lower the drive as low as possible without hitting the ground or trailer.

#### To deploy the step:

1. Stand behind the platform; pull the plunger out and pull up on the step at the same time.
2. Pull the step towards you; do not let go.
3. Gently let the step down; it will lock into place automatically. Do not let the stainless tube hit or rest on the drive or props at any time.

#### To raise the step:

Pull the plunger and raise the step at the same time. Be careful when folding the step over onto the platform. Do not allow the step to slam down.

Always make sure the area in the platform is clear before closing the step.

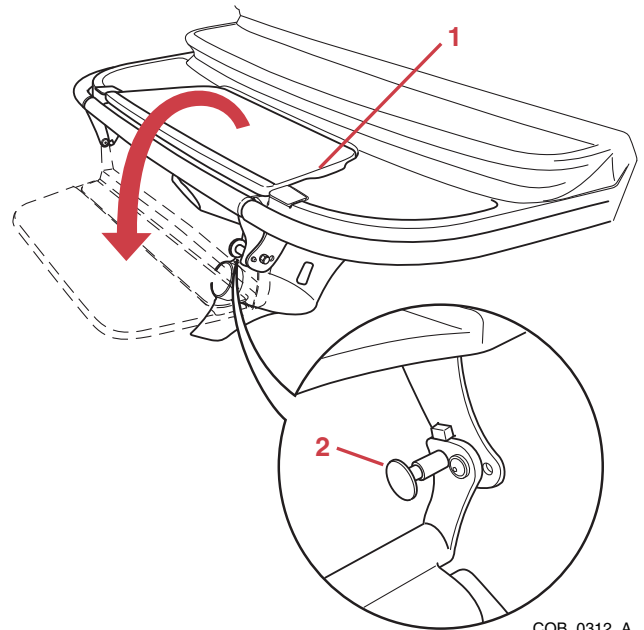

- 1 – Swim Step  
2 – Plunger

### **⚠ WARNING**

**Avoid the possibility of injury or death. DO NOT occupy the platform or use the ladder when the engine is running or engaged. Propeller contact or exposure to CO can cause severe injury or death. All gasoline engines produce CO. CO is colorless, odorless and dangerous. Direct and prolonged exposure to CO will cause brain damage or death. The stern drive unit and the propeller have many sharp edges.**

**The extended swim platform must be attached to the boat when it is in use. The boarding ladder is attached to the boarding platform. The removable feature is for boat storage only.**

### **⚠ WARNING**

**Avoid injury or death. DO NOT overload the flip down swim step. The swim step maximum load is 400 lbs (181 kg).**

## VOLVO PENTA OCEAN SERIES OUTDRIVE

Your boat may be equipped with an Ocean Series Outdrive from Volvo Penta. In addition to a composite outdrive, there is a Neutra-Salt switch located in the helm area of your Cobalt boat. Please refer to the Neutra-Salt Operator's Manual located in your boat bag for operating information.

## WINDSHIELD LATCH

To open the windshield make sure the vertical slots in the mechanism are aligned. Swing the windshield open until the windshield post falls into the vertical slots and the mechanism locks.

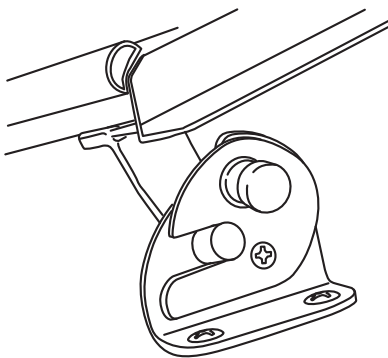

COB\_0095\_A

To close the windshield, release the locking mechanism by pulling the forward-facing button. Swing the windshield into place.

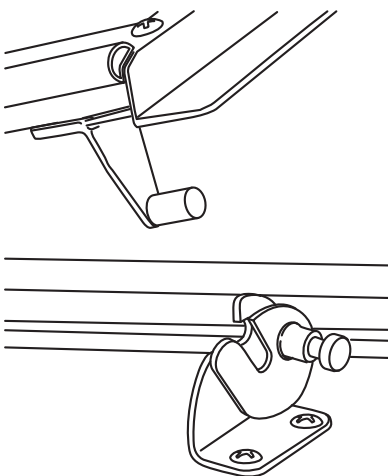

COB\_0096\_A

## COCKPIT DINETTE TABLE - OPTIONAL

Remove the j-shaped table leg from the starboard bow storage area. Slide the leg into its mounting support. Slide the table top onto the leg. If your table top has a lever, tighten the lever.

Your optional dinette table may be made of teak. To keep teak in top condition, clean it occasionally with a teak cleaner and re-oil it at least once a season.

## ICE CHEST

The ice chest can be accessed by lifting the cushion UP and OUT.

## REMOVABLE BOW SEAT CUSHION - OPTIONAL

Additional bow seat can be created by inserting the bow filler cushion. Place the cushion into position by sliding the cushion support under the bow seat, then slide the bow cushion in and push into position.

## AIR COMPRESSOR - OPTIONAL

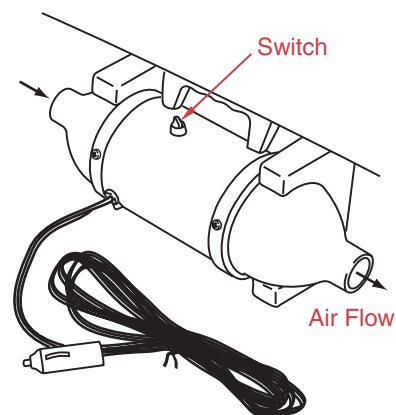

COB\_0101\_A

A high-volume air compressor is conveniently located in the port cockpit storage compartment to inflate your favorite water toys. Plug into the accessory receptacle on the dash or in the air compressor area.

# OPERATING INFORMATION

Avoid direct exposure to water and keep stowed when not in use.

## ANCHOR LIGHT

To install anchor light insert pole into socket and turn clockwise until it locks into place.

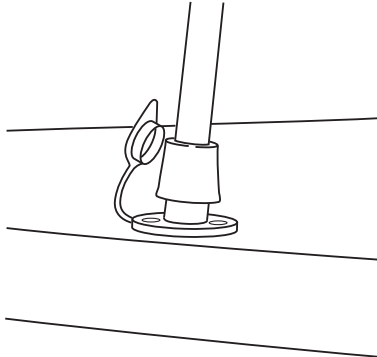

COB\_0097\_A

Cap the anchor light socket when the anchor light is removed.

## CRUISE CONTROL - OPTIONAL

### WARNING

**Avoid injury or death. DO NOT use the cruise control feature as a means for navigation or for “no hands” operation.**

To operate the Cruise Control speed control system, set desired speed. Once your boat reaches the set speed, the Cruise Control will hold the speed constant. For additional operating information, refer to Cruise Control operator's manual in your owner's packet.

## BATTERY SWITCH

The dual battery switch provides isolation and positive disconnect from the batteries to protect against tampering, electrical fire hazards and battery rundown. The switch should be in the ON position rather than the COMBINE BATTERIES position. You can operate the boat with the switch in the COMBINE BATTERIES position, but this is not recommended for extended periods. In the OFF position, the boat will be isolated from the batteries except for the automatic bilge pump.



**NOTICE: The purpose of dual batteries is to keep one dedicated mainly to engine starting and one dedicated to operating the majority of the boat. In the COMBINE BATTERIES position, one larger battery is essentially formed. If a failure should occur with the electrical systems or either battery, both batteries will end up discharged.**



**NOTICE: On dual battery installations, there is an ACR installed that will allow the engine to charge the second battery.**

## BATTERY CHARGER - OPTIONAL

See specific operating instructions located in your boat bag or consult your Cobalt dealer for further information.

## AUTOMATIC CHARGING RELAY (ACR)

The automatic charging relay (ACR) automatically combines the batteries when the engine is running. It also isolates the batteries when discharging to prevent the starting battery from discharging while using the house battery when the engine is off. The ACR has the following features:

- 120 amp continuous rating
- 12/24V DC auto ranging voltage input
- Senses charging on two battery banks
- Side and bottom knockouts for cable connections
- Clip-on cover insulates terminal connections
- Integrated LED indicates ACR status
- Waterproof – rated IP67 for temporary immersion

## FRESH WATER - OPTIONAL

The freshwater system provides potable (drinkable) water to the sink and transom shower. Refer to *Section 1, Specifications*, for the capacity of the water system.

As standard procedure, the water system is winterized from the factory and water is non-potable. DO NOT DRINK. The system must be cleaned and disinfected before the first use.

The system is operated by a 12V DC water pump located in the engine compartment. It is necessary for the 12V DC system to be energized and the WATER PRESSURE switch to be turned on to operate the water system.

The water pump works on demand. It will not automatically shut off when the freshwater tank is empty. Monitor the level of water in the tank. If the water pump is allowed to run continuously, it may overheat.

To clean and disinfect the water tank, refer to *Section 6, Water Systems (if equipped)*.

Consult your authorized Cobalt dealer for winterization requirements.



# OPERATING INFORMATION

## BOW TONNEAU COVER - OPTIONAL

Follow these procedures to attach the bow tonneau cover:

1. Open walk-thru doors.
2. Starting at bow, slip bow opening over bow, work aft, and snap the cover to the boat.
3. Close windshield center door and snap the canvas to the underside of the windshield.
4. Install the adjustable tonneau cover support pole. Make sure the pole is perpendicular to the floor and adjust to “tent” the cover.
5. Walk-thru doors may be closed if desired.

Do not use bow tonneau cover for extended storage. It is not designed for storage, but can be used for overnight storage or trailering.



**NOTICE: Always double-check snaps are secure.**

## COCKPIT TONNEAU COVER - OPTIONAL

Follow these directions for the cockpit tonneau cover.

1. Unroll the cover and snap to the deck, starting at the center of the windshield. Snap to the forward outside edge of the windshield only.
2. Install tonneau support pole(s) to underside of the cover (just in front of rear seat) with snap and adjust pole to approximate height of windshield. Some models have two support poles. Make sure the poles are perpendicular to the floor and adjust to “tent” the cover.
3. Pull elastic cords over discs on transom, starting in the center and working outboard (you may have to readjust the support poles for proper fit).
4. Continue snapping up the sides.
5. The walk-thru doors may be closed if desired.

Do not use cockpit tonneau cover for extended storage. It is not designed for storage, but can be used for overnight storage or trailering.



**NOTICE: Always double-check snaps are secure.**

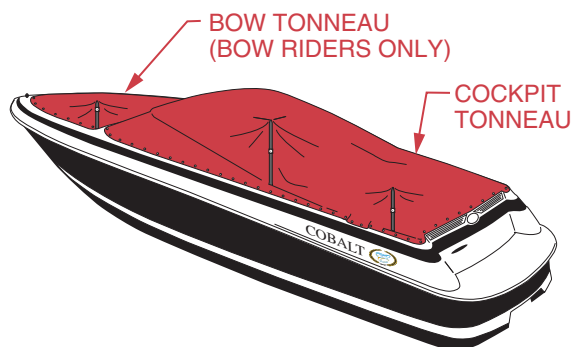

COB\_0138\_A

## PREMIUM BIMINI TOP - OPTIONAL



**NOTICE: Do not operate equipment that has loose or missing fasteners. Be sure all fasteners are installed and properly tightened before operating equipment.**

1. Remove the stainless adjustable arms from the storage area.
2. Unfold the top and install the stainless adjustable arms (tensioners) into the quick-disconnect fittings on the deck, forward of the windshield. Secure the forward arms to the forward cross members with the pins.
3. Tighten the bimini by twisting the tensioners.
4. When the top is up, make sure the light wire is routed correctly and the navigation light is properly secured.

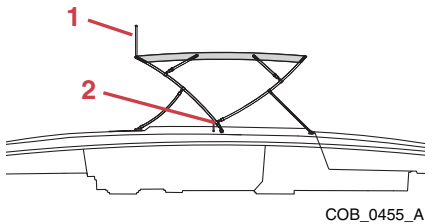

COB\_0455\_A

- 1 – Navigation Light
- 2 – Light Wire

5. To assist in laying the bimini down for storage, there are 4 knobs and lanyards in the glove box that can be installed instead of the socket-head bolts and slotted screws, if desired.

Do not trailer with the bimini top up. Store and trailer the bimini top in the stowed position, in its canvas boot.

## PREMIUM BIMINI TOP WITH EASY FOLD - OPTIONAL



**NOTICE:** Do not operate equipment that has loose or missing fasteners. Be sure all fasteners are installed and properly tightened before operating equipment.

1. Remove the stainless adjustable arms from the storage area.
2. Unfold the top and install the stainless adjustable arms (tensioners) into the quick-disconnect fittings on the deck, forward of the windshield. Secure the forward arms to the forward cross members with the pins.
3. Tighten the bimini by twisting the tensioners.
4. When the top is up, make sure the light wire is routed correctly and the navigation light is properly secured.

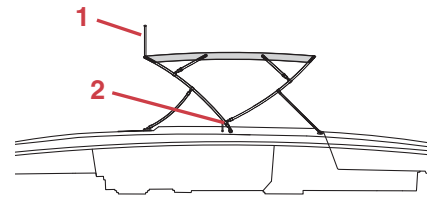

COB\_0455\_A

- 1 – Navigation Light
- 2 – Light Wire

5. To assist in laying the bimini down for storage, there are 4 knobs and lanyards in the glove box that can be installed instead of the socket-head bolts and slotted screws, if desired.

Do not trailer with the bimini top up. Store and trailer the bimini top in the stowed position, in its canvas boot.

6. To fold down the bimini top, release the port side lever.

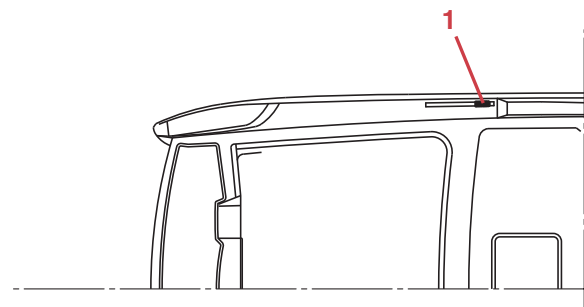

COB\_0456\_A

- 1 – Port Side Lever

7. Move to the starboard side, lift up and hold the release lever and fold down the bimini top.

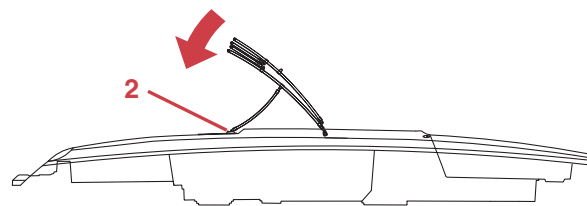

COB\_0458\_A

- 1 – Release Lever

8. Once the top is folded down, secure the locking levers into the aft locking position.

# OPERATING INFORMATION

## ELECTRIC ECLIPSE ARCH WITH BIMINI

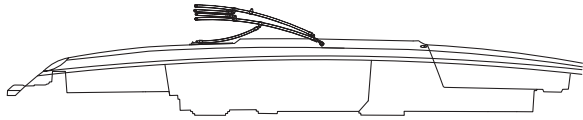

COB\_0457\_A

9. To deploy the bimini top, reverse the above procedure.

## ECLIPSE ARCH W/BIMINI



**NOTICE: Do not operate equipment that has loose or missing fasteners. Be sure all fasteners are installed and properly tightened before operating equipment.**

1. Fold aft bimini bow toward the back of the boat.
2. Remove canvas boot.
3. Unfold canvas and deploy over the top of the arch, and put the hole in the canvas over the anchor light on top.
4. Move forward bimini bow to top quick release position, and attach the short bimini poles to the forward bow and quick release.
5. Unzip forward bow support pocket on the canvas and put over forward bimini bow and rezip canvas.
6. Pull the aft end of bimini down tight using adjustable poles to hold tight.



**NOTICE: Do not operate equipment that has loose or missing fasteners. Be sure all fasteners are installed and properly tightened before operating equipment.**

1. To raise and lower, turn on the master switch in the helm area, and raise and lower with the switch located in the aft walk-thru area.
2. Fold aft bimini bow toward the back of the boat.
3. Remove canvas boot.
4. Unfold canvas and deploy over the top of the arch, and put the hole in the canvas over the anchor light on top.
5. Move forward bimini bow to top quick release position, and attach the short bimini poles to the forward bow and quick release.
6. Unzip forward bow support pocket on the canvas and put over forward bimini bow and rezip canvas.
7. Pull the aft end of bimini down tight using adjustable poles to hold tight.

## BLACK/WHITE ELECTRIC OR FOLDING ARCH WITH SUNSHADE



**NOTICE: Do not operate equipment that has loose or missing fasteners. Be sure all fasteners are installed and properly tightened before operating equipment.**

Canvas should be stored in a protective covering to avoid damage to the canvas when not installed.

### Installation

1. Remove canvas from protective covering. Unfold the canvas and identify the bow and stern areas of the canvas. The bow section will have three flaps with zippers.
2. Position the canvas on the top side of the sunshade tube frame. The long zipper located near the ski pylon will be running the length of the boat when installed. The three forward flaps will be positioned evenly between the framing of the sunshade.
3. Open the three forward flaps and wrap the flap around the forward tube, then zip. There is a small Velcro flap for securing the zipper pull.
4. Ensure the long zipper on the aft end of the canvas is zipped closed. Locate the flaps near the center of the underside of the canvas. These flaps will align with the tubing going side-to-side on the sunshade. Wrap the flaps around the tube and secure the Velcro flaps.
5. Open the three aft flaps on the canvas and locate the two straps sewn to the inside of the center flap. Unbuckle the straps. The end, sewn to the flap, will drop down below the aft side of the tube, then re-attach to the end, sewn to the underside of the canvas. This will allow you to pull tension on the canvas as you complete the deployment.
6. Pull the canvas tight from bow to stern by rotating the canvas around the aft tube and pulling on the two aft straps. Then secure the Velcro flaps.
7. Once the canvas is snug bow to stern, open and secure the side flaps to the outer tube framing of the sunshade. Pull the canvas tight side-to-side by rotating the flap around the tubing and securing the Velcro flap.



**NOTICE: The small straps/buckles located inside the aft corner flaps should be folded up and stored inside the flap when installed. These straps are for securing the sunshade in the folded position only.**

### Removal

1. Open all Velcro flaps.
2. Release the two aft buckle straps.
3. Unzip the three forward flaps.
4. Remove from the sunshade. Be sure the canvas is clean (no debris) before folding and storing into the protective cover.

### Folding the Sunshade and Arch



**NOTICE: The canvas can be installed when folding the sunshade. Folding the sunshade can assist in storing WAKE SURF boards on the topside of the sunshade.**

1. Board racks may be turned to the inside of the boat ONLY if there are no boards held in place. If boards are being held by the board racks, then the racks must be turned outside of the boat before folding the sunshade.
2. Locate the RED knobs on the underside of the sunshade.
3. Turn the knobs counter-clockwise to untighten. The knobs will spin loose and drop down but will not fall out.
4. Stand behind the sunshade and pull down on the aft handhold located on the aft end of the sunshade. The forward end of the sunshade will raise, and the aft end will tilt down. The sunshade will tilt about 25°.

# OPERATING INFORMATION

5. Proceed with folding the arch. Refer to owner's manual for operating electric arch or manual arch.
6. Open aft corner flaps of canvas. Release the buckles on the small straps. Loop the strap down around the aft leg of the arch, buckle and pull tight. This will secure the sunshade from "bouncing" or rotating forward if the boat is being transported with the arch/sunshade in DOWN position. If the canvas is not installed, use the separate straps provided. Locate these straps in the same position.

Reverse process to raise and secure sunshade.

## Surf Pockets

1. Pockets are approximately 18" wide and 12" deep - triangle shape.
2. A 2" wide strap/buckle secures the aft end of the board.



**NOTICE:** Due to various board manufacturers and different styles of boards available, not all boards will fit.

## SS ARCH WITH BIMINI INSTRUCTIONS - OPTIONAL



**NOTICE:** Do not operate equipment that has loose or missing fasteners. Be sure all fasteners are installed and properly tightened before operating equipment.

1. Push bimini top forward mounting rib towards front (bow) of boat.
2. Unfurl bimini top from forward rib and use snaps to attach loose end to rear side (aft) of SS arch.
3. Install two forward support bars near front sides of windshield and tighten the bimini top by twisting the tensioners.

### **DANGER**

To avoid injury or death, do not use the arch for towing or as a support. It is not designed to hold the additional weight.

### **CAUTION**

The arch with bimini is designed for Cobalt factory-installed equipment only. Do not add any additional equipment without authorization from Cobalt.

**⚠ WARNING**

Arches or towers are designed to tow a wakeboarder. Do not tow other boats, tubes, parasails, etc. Do not climb, jump or dive off the tower. Do not sit behind the tower where you could come in contact with the rope. Do not allow loose ropes to hang from the tower. Do not trailer the boat with boards or skis in the racks. Before and during each use make sure all bolts and fasteners are tight. Make sure you have sufficient clearance above the tower when it is up. Watch for bridges, power lines, tree limbs and other low hanging obstacles. Failure to follow these instructions can lead to serious injury or death.

**SKI TOW EYE/PYLON**

The stainless steel ski tow and stainless steel ski tow pylon are designed for a single skier only. The ski tow pylon may be located at the stern of the boat or on the ski tower.

**⚠ WARNING**

Avoid injury or death. **DO NOT** overload the ski tow, ski tow eye or the ski tow pylon, or use them for anything other than water sports. The ski tow eye and the ski tow pylon maximum load is 1,000 lbs (454 kg).

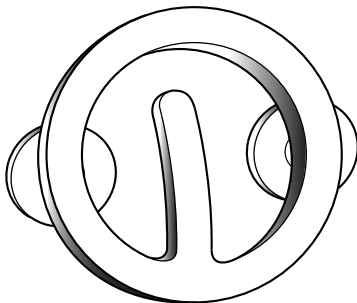

COB\_0245\_A

**TIE-DOWN LOCATIONS**

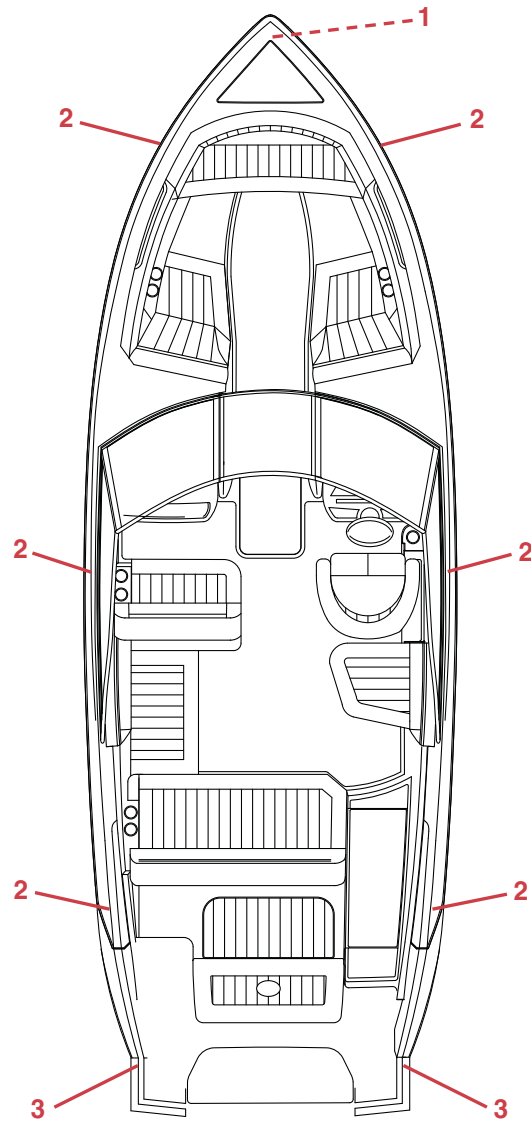

COB\_0364\_A

- 1 – Bow Eye
- 2 – Cleats
- 3 – Stern Eyes

**⚠ WARNING**

Avoid injury, death or property damage. Never anchor a boat from the stern, and keep the boat headed into the waves.

# OPERATING INFORMATION



**NOTICE:** Only use properly positioned slings to lift your boat. Do not use deck cleats to anchor or for towing. If towing, only use the bow eye or the stern eyes in a bridle manner.

Tie-down locations are for keeping your Cobalt boat secured when moored. The bow eye and/or stern eyes can also be used. Refer to *Section 3, Anchoring*.

## TRANSOM TILT SWITCH - OPTIONAL

The remote transom tilt switch allows you to raise or lower the drive unit from the stern. The remote tilt switch is connected directly to the battery switch and does not require the ignition key to be on. If your boat has twin engines, each drive unit will have a switch.



COB\_0151

## MOTOR BOX ASSEMBLY OR ELECTRIC MOTOR BOX ASSEMBLY

### DANGER

Avoid injury or death. **DO NOT** occupy or operate an engine when the motor box is open. The motor box assembly is a machinery guard.

### CAUTION

Avoid injury or damage to your boat. The motor cover is heavy and may require more than one person to lift. If lifting the box manually, position one person at each grab handle and lift straight up. Place support into position.

Do not operate the motor box assembly if your ski tow is installed. Damage to the motor box, hinges, ski tow and lifting unit can result. Before opening the motor box, make sure the ski tow is removed, no items are on top of the motor box and any cushions, inserts or stored equipment are secure or removed. Use the motor box support to support the box once it is open. Be sure to return the support back to its stow position and clear any obstructions before closing the box. Wind and conditions may allow the motor box to open beyond its limits; use caution during these conditions.

The electric motor box assembly is controlled by its switch at the helm. In the event of battery failure or storage, the motor box can be opened manually.

## TOOL KIT - OPTIONAL

A tool kit assists you with correcting minor mechanical and electrical problems. For location of the tool kit, refer to *Section 1, Layout*.

**NOTES**





# SYSTEMS

## INTRODUCTION

This section discusses the mechanical, electronic, and manual operating systems of your Cobalt boat. It describes basic operating characteristics and provides information for efficient use of the equipment, and for prevention of casualties. Be sure to read and understand all information provided before operating its systems.

### **WARNING**

**Avoid injury, death or damage to equipment. Regularly inspect and maintain all systems to prevent unexpected hazards associated with worn or faulty components. Be sure to replace system components and hardware with marine grade parts, not automotive components.**

**FUEL ROUTING**

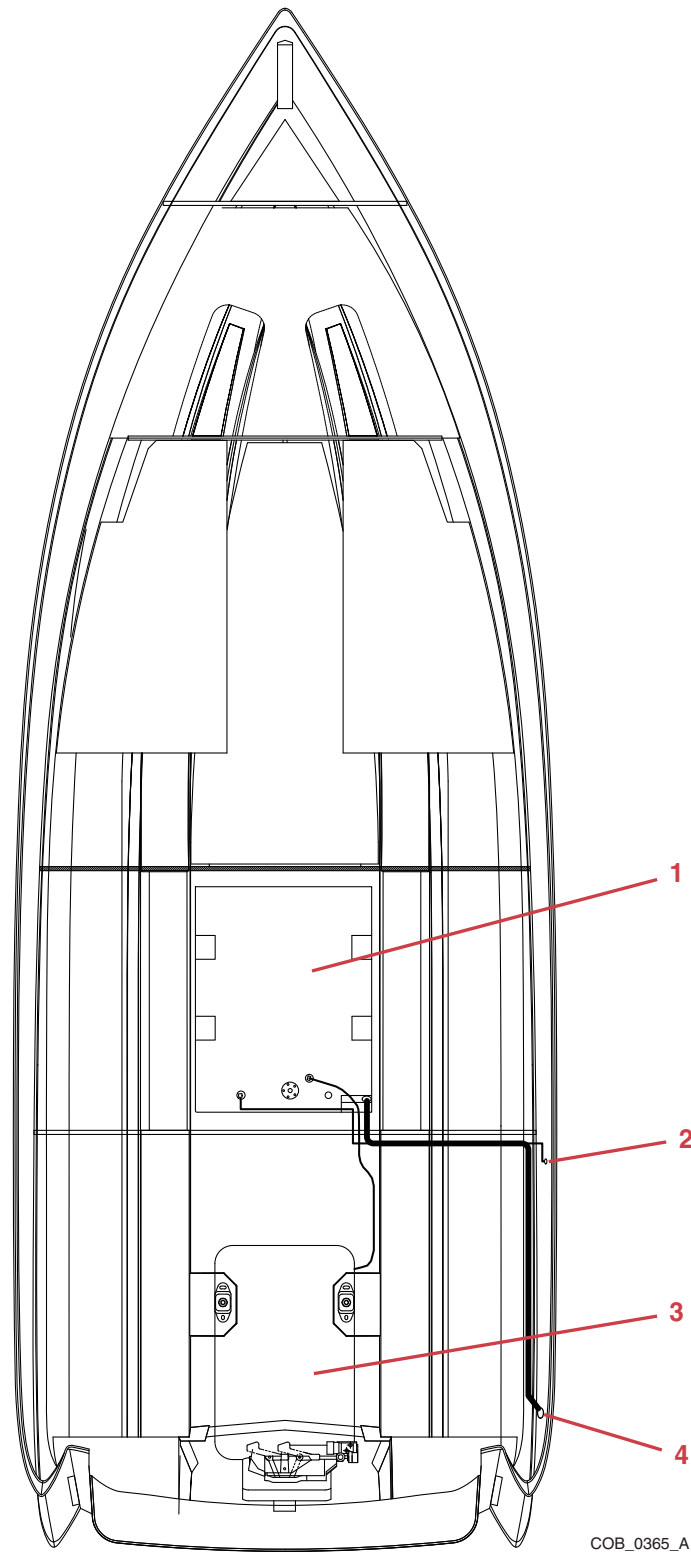

**1 – Fuel Tank**  
**2 – Fuel Vent**

**3 – Engine**  
**4 – Fuel Fill**

**WATER/PLUMBING**

**Fresh Water**

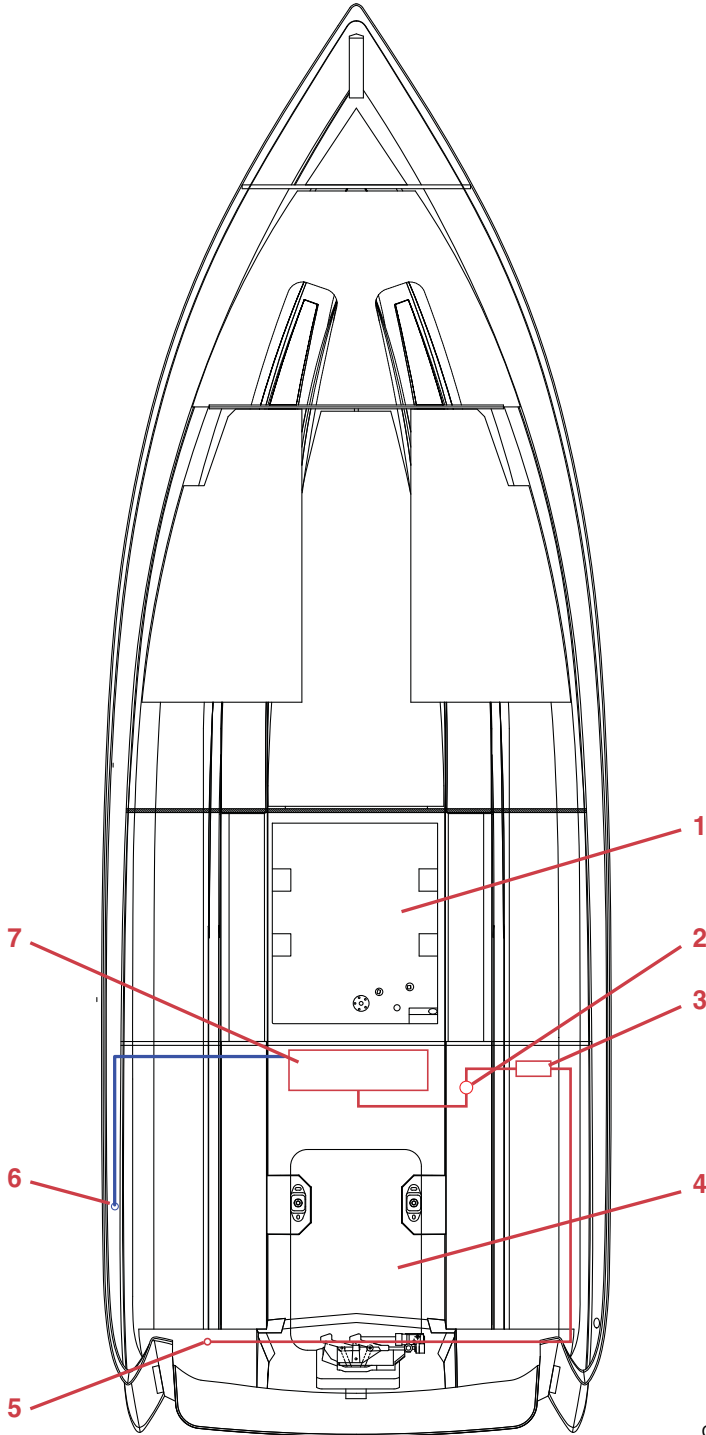

COB\_0366\_A

- 1 – Fuel Tank
- 2 – Water Filter
- 3 – Water Pump
- 4 – Engine

- 5 – Transom Shower
- 6 – Fresh Water In
- 7 – Water Tank

## Water System

If your Cobalt boat is equipped with a transom shower, standard or optional galley, the system allows for fresh water to be onboard. A 12-volt DC water pump operates the system. It is necessary for the boat's battery(ies) to be turned on for the water system to operate. Refer to *Section 1, Specifications*, for your boat's freshwater capacity. Consult your authorized Cobalt dealer for winterization requirements.

## FIRE SUPPRESSION EQUIPMENT

If your Cobalt boat is equipped with a fixed automatic fire extinguisher that uses FE-241 (or optional FM-200, for European requirements) as an extinguishing agent, it is mounted on the engine compartment and generator compartment (if equipped). These extinguishers are activated when the heat-sensitive head reaches a predetermined temperature. The extinguisher discharges and saturates the engine and/or generator compartment, smothering the fire.

Inspect fire extinguishers for proper charge before operating the boat.

### WARNING

**Avoid injury, death or explosion. DO NOT open the engine compartment hatch immediately. This will allow oxygen to the fire, and flashback can occur. When the fire extinguisher discharge occurs, turn off all engines, bilge blowers and electrical system components.**

## ELECTRICAL SYSTEM

Your Cobalt boat has a 12-volt negative ground DC system. The positive wire is hot, and feeds current from the batteries to all 12-volt equipment; the negative wire is the ground.

The DC components are controlled from the helm switches after the battery switch. If your Cobalt boat has a cabin, it may have an electrical system panel that supplies 12 volts to these types of accessories:

- Cabin lights
- Cockpit lights
- Head
- Freshwater pressure pump
- Air compressor
- Entertainment system

## **CIRCUIT BREAKER PANEL**

Most electrical standard equipment devices are controlled with circuit breakers located in the starboard bow storage compartment. The breakers are labeled to identify the device protected. These breakers will activate if overloaded and cut power to the switch. To restore power, turn off the device, push the breaker button in and release. If the button continues to pop out when the device is used, see your authorized Cobalt dealer. Your boat may not be equipped with all of these features or options.

## FUSES

Some accessories or electrical components have in-line fuses in them. Check the failed component for the possibility of an in-line fuse if a tripped circuit breaker is not found. Some of these accessories or electrical components may not be included or available on your boat.

## BATTERY CONNECTIONS

### **⚠ WARNING**

**Avoid the potential of explosion from shorting or arcing. Keep the battery connections tight and clean, the terminal covers in place and the battery(ies) secure in the restraint system.**

Loose battery connections can cause errant signals to the boat's electrical system.

Read and understand the safety information on or supplied with your battery(ies). Maintain the battery(ies) following the manufacturer's recommendations.

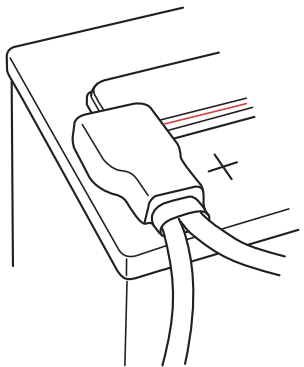

COB\_0090\_A



# INTERIOR/EXTERIOR CARE

The best way to take care of your Cobalt boat is with prevention and proper care. All of the care methods within this section may not apply to your boat.

## VINYL INTERIOR AND UPHOLSTERY

The vinyl and interior fabric in your Cobalt boat has been specially selected to take the tough punishment of the elements and hard usage of an active boater. Avoid sharp objects that may cut or tear your vinyl.



**NOTICE: This article contains the biocidal product n-octyl isothiazolinone (OIT), an antifungal additive used to help maintain appearance, physical properties and prolong the service life of this article.**

### Care and Cleaning of Vinyl

Most common everyday light soiling can be easily removed by using a solution of 10% liquid household dish soap and 90% warm water, applied with a clean dampened cloth. Rinse with a clean cloth dampened with water and allow to dry. Moderate scrubbing with a soft-bristle brush will help loosen dirt and grime embedded in the grain of the vinyl.

See specific cleaning instructions located in your boat bag.



**NOTICE: It is extremely important to clean the stained area as quickly as possible, making sure the recommended cleaning steps are followed in order.**

**⚠ DANGER**

**Avoid fire or explosion. Avoid open flame or spark. Flammable liquids are extremely dangerous and must be used in well-ventilated areas.**

### Dark Stowage Areas

Often, when a boat is stored completely covered or in a dark building, the vinyl will darken or become “dingy” looking. If this happens, simply place the boat in direct sunlight for a few hours and the vinyl will brighten up.

### Leather Care

For spots and spills, wipe up excess liquid immediately with a clean absorbent cloth or sponge. If necessary, use clean lukewarm water only and let air dry naturally. If water is used, clean the entire area where the spot occurred. For example, clean the entire seat cushion or entire arm. Do not dry wet areas with hair dryers.

For stubborn spots and stains, use a mild non-detergent cleaner such as a bar of Ivory Soap™ or Amway™ L.O.C. Apply the soap to a clean, wet sponge, wash, then rinse well. Let air dry naturally.

For butter, oil or grease, wipe any excess off the leather with a clean dry cloth, then leave it alone; the spot should dissipate into the leather in a short period of time. Do not apply water or try to wash a butter, oil or grease spot.



**NOTICE: DO NOT use saddle soap, cleaning solvents, furniture polish, oils, varnish, abrasive cleaners, soaps or ammonia water.**

## SEA GRASS FLOOR COVERING CLEANING INSTRUCTIONS

### General Maintenance Instructions

Plynyl® is made with a woven vinyl fabric bonded to commercial-grade backings. Vinyl is a very tough, durable material and few household or common office chemicals affect it. Routine maintenance along with periodic cleanings and diligent attention to stain-causing spills will provide a long useful life.

The frequency of routine maintenance depends on the application. The frequency has to be determined by the user or through consultation with the manufacturer. The methods for routine maintenance as well as cleaning methods also depend on the application. Frequency depends on the amount of soil and dirt Plynyl is exposed to. Dirt and soil will degrade any flooring, so proper maintenance will increase its natural life cycle.

Plynyl is unique among soft floor coverings because water can be used effectively in daily maintenance. Detergents and shampoos with a pH up to 11 can be used repeatedly and safely. However, it is recommended to use the lowest pH detergent that provides a satisfactory result. When using water with any of the maintenance techniques listed, be sure not to leave any standing water and keep foot traffic off the floor until it is completely dry. Also, do not over-wet areas to be cleaned.

Do not use acetone, Pine-Sol® or citrus-based cleaners, as they can damage Plynyl. Solvents containing xylene or toluene may be used in a limited fashion as a spotting agent. See Spot and Stain Removal.

Plynyl w2w and tile are not absorbent and therefore are not recommended to be used in street-level entrances as walk-off mats.

It is recommended that a walk-off mat be provided in every installation to reduce the tracking of soil and other foot-borne contaminants onto the Plynyl floor. If a walk-off mat is not provided, it will result in premature wear of the Plynyl installation.

Sealers, waxes, stain repellents and other topical applications are not required for Plynyl. Using a powder cleaner such as HOST is not required; it does not result in more effective cleaning.

Direct contact between natural rubber and Plynyl will cause discoloration in Plynyl. Avoid the use of rubber castors, furniture pads, or other rubber pad or cushion products.

It is necessary to use chair pads under rolling chairs to protect Plynyl fabric and seams.

### Maintenance Techniques

The most common and easily accessible maintenance options are the vacuum cleaner and mop. Either is effective in picking up and removing dirt. If a vacuum cleaner is used, the beater brushes should be lowered so it brushes the surface of the Plynyl to release dirt and brush out scuffs.

In the absence of additional cleaning methods noted in Periodic Comprehensive Cleaning, mopping is slightly more effective than a vacuum cleaner because you can use a detergent with a mop. If a detergent is used in mopping, spread it out on the area to be mopped, allow it to stand 30 seconds to 1 minute and then mop the area. Rinse the mop with clean water and apply detergent again if necessary. Rinse and mop with at least one additional clean water rinse after applying detergent, as detergent residue will attract soil if not properly rinsed.



# INTERIOR/EXTERIOR CARE

For modest-sized installations, Hoover® manufactures a floor-cleaning machine called the Hoover FloorMATE™, which was designed especially for flat-surfaced floors such as wood and tile. It works very well with Plynyl as well. It uses water, detergent and rotary scrub brushes to aggressively remove soil and dirt. Follow the manufacturer's instructions for use. It can be used for the home but will work well for some smaller commercial applications as well. You can find it at [www.hoover.com](http://www.hoover.com). The FloorMATE works well with Crystal Dry™ as well; see Periodic Comprehensive Cleaning (1).

## Periodic Comprehensive Cleaning

There are several methods that work well.

1. The Whittaker GLS™ Carpet Cleaning System with Crystal Dry™ works very well in combination with routine vacuuming. This system relies on Crystal Dry, a detergent that suspends soil into dry crystals that can then be vacuumed easily. Crystal Dry's advantage over conventional detergents is that it does not leave a soapy residue, which may attract more dirt. Periodic cleaning with Crystal Dry would be done using the GLS, Whittaker's carpet cleaning machine. The GLS has twin cylindrical counter rotating brushes that are effective in removing soil from Plynyl without abrading the fabric. You can find Whittaker products at [www.rewhittaker.com](http://www.rewhittaker.com), or call them at 800-422-7686. GLS, Crystal Dry and Carpet Roamer are all trademark names of the R.E. Whittaker Co.
2. Crystal Dry by Whittaker can also be used with a rotary bonnet and pad. It is recommended to saturate a cotton microfiber pad with Crystal Dry to clean the floor. Care should be taken to make sure the pad stays moist. It is not necessary to rinse Plynyl after treating with Crystal Dry.
3. Plynyl can be cleaned with a rotary bonnet and pad and conventional detergents. The pad should be a green striped cotton pad available from most industrial suppliers such as Grainger. First, a detergent should be applied to the surface and allowed to stand for 30 seconds to 1 minute. Pass over the floor three to four times with the rotary bonnet and pad. To pick up the detergent, pass over the floor again with the rotary bonnet but with a clean, dry cotton pad. Care should be taken to remove all detergent residue or it may attract more dirt. Care should be taken not to abrade Plynyl with the rotating pad. Hard-to-remove stains should be treated by hand, not machine, as per instructions in Spot and Stain Removal.
4. For large installations, cleaning can be accomplished with an auto-scrubber. When using an auto-scrubber, activate its scrubber brushes and vacuum bar, and set the automatic solution dispenser on medium to high. Follow the manufacturer's recommendations to get the best results from the equipment. Do not exceed an 11 pH for chemicals used in the machinery. As noted earlier, care should be taken to remove all detergent residue or it may attract more dirt.
5. Interior Preservation Inc. (IPI) is an approved maintenance provider. They have a nationwide network of service providers. Call Tony Doria at 800-820-0008 extension 109 for a local provider.

### Spot and Stain Removal

Even with routine maintenance, stains and spots will occur. Clean up spills as quickly as possible. Watery spills should be blotted with clean cloths or paper towels. Thick jelly-like substances should be removed with a spoon or blunt scraper, and then blotted. Solids should be scraped using a blunt scraper and then swept, brushed or vacuumed to remove the material. After removal of the majority of the spilled material, it is important to complete the removal process so the spill does not have a chance to affect the flooring.

Whittaker manufactures a spotting and brushing system using Crystal Dry Spotter and Cleaning Agent and the Whittaker Carpet Roamer™; it is effective in cleaning the stains listed on the next page where brushing is required. Plynyl is stain-resistant, not stain-proof. To avoid lasting stains, blot and clean stains immediately. The following list shows stain-removal procedures for some common spills and other tough-to-clean areas.

Stain	Removal Procedure
Shoe heel marks	Use medium-bristled scrub brush and follow with mild detergent solution.
Blood, chocolate, catsup, white glue, egg, ice cream, butter	Spray on a mild detergent solution and allow it to dwell for 1 minute. Brush with a medium-bristled scrub brush, and then blot with white paper towels. Repeat until discoloration is removed.
Berries, fruit juices, cream, soft drinks, milk, wine, beer, coffee, tea	Spray on a mild detergent solution and allow to dwell for 1 minute. Blot with white paper towels. Repeat until discoloration is removed.
Excrement, vomit, urine	Spray on a mild detergent solution and allow it to dwell for 1 minute. Brush with a medium-bristled scrub brush, and then blot with white paper towels. Repeat until discoloration is removed.
Shoe polish, asphalt, grease, oil, ink, lipstick, crayon, wax, paint, rubber cement, seam sealer	Remove as much residue as possible using white towels, paying attention to keeping the stain from spreading. Use a mild solvent (Bane Clene Saf-T-Solv®) placed on white towels and then applied to the stained area. Repeat the application of the solvent and gently agitate the area as much as needed. Overapplication of any solvent can dramatically affect the integrity of Plynyl. Follow solvent cleaning with a detergent rinse.
Mercurochrome, Merthiolate, Betadine, tomato sauce, spaghetti sauce	Spray on a mild detergent solution and allow it to dwell for 1 minute. Blot with white paper towels. If discoloration is not removed, dilute household bleach to 1:10 bleach to water, mist on affected area and allow it to dwell for 5 minutes. Rinse with water to remove all bleach residue.
Chewing gum	Freeze with compressed air and break away from material surface. Follow with mild detergent and a medium-bristled brush.
Rust	Treat with a reducing agent and follow with a mild detergent rinse (may require professional assistance).
Follow all cleaning procedures using common detergents with a water-only rinse in order to remove all residual cleaning agents (if Crystal Dry is used, a follow-up water rinse is not required). Allow the area to completely dry before allowing traffic in the area.	



**NOTICE: Stains that cannot be removed under the listed procedures can be treated with a 1:10 bleach to water solution. Mist the solution on the area of discoloration and allow it to dwell for 5 minutes. Rinse the area with water only in order to remove the bleach residue. Allow to dry completely before trafficking. Some stains may require a professional to complete the stain-removal process.**

# INTERIOR/EXTERIOR CARE

## CABINETY AND WOOD

### Cabinetry

Clean with any water-rinseable non-abrasive cleaner.

### Woodgrain Dash

Your Cobalt boat may be equipped with a woodgrain dash, which will maintain its natural beauty and high-gloss sheen when properly maintained.

- For routine cleaning, wipe the surface with a damp, soft cotton cloth. For thorough cleaning, wash surface with a mild solution of soap and water, and dry with a soft cotton cloth.
- Do not use cleaners or polishes containing alcohol, ammonia, abrasives, oily emollients or petroleum-based materials.
- Avoid saturating the surface with polish or wax. In some instances, foam-backed tape used in manufacturing will absorb and retain these substances and result in premature fading and/or discoloration of your woodgrain dash. If cleaners or waxes come in contact with edges, clean the surface immediately with a mild solution of soap and water.

### Teak Swim Platform

Your Cobalt boat may be equipped with a teak swim platform. To keep teak in top condition, clean it occasionally with a teak cleaner and re-oil it at least once a season. Follow the manufacturer's instructions and warnings carefully. Some cleaners and oils may damage gelcoat, vinyl, stainless or aluminum. Avoid using rust-producing steel wool pads when cleaning. Materials can be purchased from your authorized Cobalt dealer.



**NOTICE: Teak sealers and cleaners can be harmful to other materials. Make sure you thoroughly remove any spills or excess. Teak should not be varnished. The natural oils in teak will cause poor adhesion.**

**⚠ DANGER**

**Avoid fire or explosion onboard. DO NOT store rags used to treat teak onboard. Store or dispose of rags properly ashore.**

### Cedar

Wipe surface with a dry cloth or a slightly damp cloth. Do not seal or paint cedar.

## CARPET

Vacuum the carpet on a regular basis. Use household carpet stain removers and cleaners to clean the carpet.

## DECK AND HULL

The finish on your Cobalt boat is known as gelcoat. The gelcoat used by Cobalt Boats is the finest available on the market today. With all its properties, it is not impervious to the elements and many types of water conditions.

### Cleaning Deck and Hull

A multi-purpose boat soap\* should be used to clean exterior fiberglass/gelcoat surfaces on your Cobalt boat after each use. This product, depending upon the ratio mixed, is designed to clean anything from dirty hulls and decks to greasy engines. Always rinse and wipe off the finish with a damp towel or chamois.

A fiberglass restorer/wax\* should be used to remove heavy oxidation, characterized by a chalk/faded surface as well as rust and exhaust stains. This product will not only remove the oxidation, but also leaves a wax protection on the cleaned surface in one easy application.

## Deck and Hull Care

Paste wax\* will help retard UV light damage. We suggest three coats be applied at the end or the beginning of the season, depending on the type of winter boat storage (covered, enclosed storage facility), and again mid-season.

To extend the life of your gelcoat finish, use a Cobalt marine mooring cover totally covering the top deck of the boat for maximum protection. Additionally, if your boat is to be stored where the sun is constantly on the side or transom of the boat, you should consider having some custom skirting made to complement the mooring cover.

Tonneau covers will supply adequate short term protection to the interior, but will not protect the gelcoat finish. Please check with your authorized Cobalt dealer for more information on the subject.

## Swim Platform Mat Care and Maintenance

### General Cleaning

Regular cleaning can be accomplished by simply washing the mats with mild soap and water and a medium to stiff bristled brush. Boat washing soap or other mild detergent, water and a hose works well. Although the swim platform mat is stain resistant, certain things, such as food, wine, fish blood or grease, may stain the mats if they are left in contact for an extended period of time. It is always best to clean or rinse away any spills as soon as possible. Work the cleaner into the stain with a stiff bristle brush, brushing with the grain texture, and rinse with a hose to finish.

Suggested cleaners:

- Simple Green®
- Soft Scrub®
- Fantastik®
- Formula 409®

(Bleach may be used, but avoid any acid-based cleaners like FSR.)

Things to avoid:

- Sharp objects such as knives or tools dragged across the surface
- Pressure washing due to the risk of shredding or cutting the mats
- Extended contact with petroleum based products. This can cause a stain that may not be able to be removed.

### Storage

The swim platform mat is very resistant to most weather conditions including sun and rain. It is, however, best to keep your boat, kayak or other vehicle covered or stored indoors to extend the life of your mats. It should be treated the same way you would treat vinyl marine seats or carpet in a boat. Excessive exposure to sunlight will decrease the life of the mats and result in fading.

### Focused Refracted Light

Much like a magnifying glass, certain things on a boat can cause focused light, which can cause blushing or burning of the surface on your swim platform mat. This is a very rare occurrence when actually using the boat, but if you leave your boat on a dock, lift or trailer, and the sun is at the correct angle, this can occur. The best way to avoid this is to cover the boat when you are not using it. If this happens to your mats, they are not ruined. The damage usually looks like a wet spot (a little darker) and over time, this will blend or weather back into the rest of the mat area and become less noticeable.

### Material Note

The swim platform mat foam has a memory. If you notice an indent in the mats when you remove your cover from the support pole or any other area where something with some weight has been sitting for an extended period, that mat will rebound over a short period of time back to its original shape.

\* 3M carries a complete line of fiberglass care products.

# INTERIOR/EXTERIOR CARE

## STAINLESS STEEL AND CHROME

Stainless steel, though highly resistant, is still capable of rusting, particularly in the marine environment. Initial signs of rust and corrosion, left untreated, may result in pitting and permanent damage to components. Keep your stainless steel looking new by cleaning monthly with a good quality stainless steel cleaner or polish. Always clean and polish in the direction of the grain and finish.

The following steps will help protect against such occurrences:

### Preventive Steps

Clean and wax metal brightwork prior to extended storage. In saltwater or other harsh environments, repeat more often as needed. High-quality stainless steel cleaners and conditioners are commercially available. Rinse with fresh water and wipe dry with towel or chamois after each use.

### Cleaning Stainless Steel

Remove rust or corrosion promptly using a good metal cleaner/polish. Delay may contribute to permanent finish damage. Do not use steel wool or other coarse abrasives, or clean with acids or bleach. DO NOT use cleaners that are not for use on stainless steel, such as glass, tile or counter cleaners, or citrus-based cleaners. These types of cleaners can damage the surface permanently. Apply metal or automotive wax after cleaning for additional protection. Always test any product in an inconspicuous area before applying to the complete surface.

Should you have reason to replace hardware or fasteners, be certain that replacements are correct materials. See your authorized Cobalt dealer for further information.

### DANGER

**Avoid fire, explosion or exposure to toxic materials. Some of these solvents are highly flammable and toxic. Exercise proper care in cleaning, wear protective gear and provide adequate ventilation. DO NOT store soiled rags onboard; store or dispose of rags properly ashore.**

### CAUTION

**Use caution in cleaning around stitching, wood or other decorative trim, since these solvents could seriously damage these materials.**

## CORROSION PROTECTION

### CorrosionX

One of the issues associated with owning a boat is corrosion, which, ironically, is often caused directly by the marine environment. If you operate a boat in saltwater, you will be surprised by the excessive corrosion in just a few weeks. Since we recognize that your purchase of a Cobalt boat was a major financial decision, we want you to be happy with your choice for years to come. After consulting with our dealers and operators throughout the country, we found that regular applications of a product called CorrosionX will keep your boat operating at peak efficiency, free of corrosion. To assist you, we have included a small can of CorrosionX in the optional saltwater kit. Minimally, it should be applied to the following areas and components in the time frames specified:

### Topside

Spray or wipe a light coat of CorrosionX on all rails, stanchions, cleats, cleat bolts and other metal fixtures/fittings up on deck. Treat hinges, locks, closure mechanisms and sliding tracks of doors and windows. If sprayed on, wipe with cloth to remove excess. A very light coat is all it takes and it should be applied every two months if operating in saltwater and every four months in freshwater operations.

### Inside the Bulkhead

Once a year, spray electrical connections, fuse panels and antenna bases. Light sockets should be treated at two- or three-month intervals. Every six months, treat plumbing connections in the galley and head areas. Once a year, apply to hinges, locks and sliding tracks of doors and windows to keep them properly lubricated and functioning smoothly.

### Other Areas

Treat hydraulic cylinder shafts for steering and other operating mechanisms once a month. Spray the entire engine, including engine mounts, every six months. Treat the bilge pump housing and connections plus other items in the bilge area once every three months. Thru-hull fittings and seacocks should also be treated every three months. Fuel line fittings at the fuel tank should be treated every six months.

CorrosionX is a multi-functional product with universal application. A good rule of thumb: if it rusts or corrodes, if it needs lubricating or if it is rusted shut and needs to be broken apart, it is a potential application. If you have any questions about CorrosionX, check the manufacturer's web site:

**<http://www.corrosionx.com> or  
call 800-638-7361.**

Corrosion destroys underwater metal parts and can occur in fresh water or salt water. Salt, brackish and polluted waters will accelerate corrosion.

### Galvanic Corrosion

Galvanic corrosion can result in serious damage to any metal component of your Cobalt boat that is in the water. Galvanic corrosion is the deterioration of metals due to the effects of electrolytic action. When dissimilar metals are immersed in a conductive fluid such as saltwater, an electric current is produced, similar to the action of a battery. The softest of the metals will be the first to become damaged.

Galvanic corrosion can occur in fresh water or salt water; however, salt, brackish and polluted waters accelerate galvanic corrosion.

A self-sacrificing anode can be mounted to your Cobalt boat to help prevent damage to metal components from galvanic corrosion. The anode will require frequent inspections. If the anode shows deterioration of 50% or more, it must be replaced for continued protection.



**NOTICE: DO NOT paint an anode, its fasteners or its mounting surface. Painting will reduce the anode's corrosion protection capabilities. Make sure the anode's contact to its mounting surface is clean and secure.**

Refer to the propulsion unit operator's manual and your Cobalt dealer for requirements on galvanic corrosion protection.

### Salt Water

Wash the entire boat after each use in salt water. If you continue to operate in salt water, the entire boat should be protected against saltwater damage as described in **Interior/Exterior Care**, in this section.

Refer to the propulsion unit operator's manual for manufacturer's saltwater operating recommendations.

# INTERIOR/EXTERIOR CARE

## CANVAS

### CAUTION

**Avoid damage to the canvas. Under no circumstance are these fabrics to be put in hot water, run through the hot drying cycle of an automatic dryer or steam pressed at a dry cleaner. Fabric should be line-dried.**

The optional bow and/or cockpit tonneau covers, bimini top or bimini enclosure on your Cobalt boat are manufactured from top-quality materials to provide you with years of trouble-free service.

The following information is provided to help you maintain the appearance and ease of operation.

Cobalt uses Sunbrella®, a woven fabric made of 100% solution-dyed acrylic fiber. It is very colorfast and will withstand long-term exposure to the sun (ultra-violet) without excessive fading or deterioration.

- Do not store canvas wet or in an unventilated, moist area.
- Always roll the canvas instead of folding.
- Roll the top carefully around the bows and cover with the storage boot provided.
- Your canvas is designed and intended for short-term use only. Do not use it for storage.
- Do not tow your boat with the top in the upright position.

### Cleaning Canvas

Canvas should be cleaned regularly before substances such as dirt and roof particles are allowed to accumulate on and become embedded in the fabric. The fabric can be cleaned without being removed from the installation. Simply brush off any debris, hose down and clean with a mild solution of natural soap in lukewarm water (no more than 100° F). Rinse thoroughly to remove soap. **DO NOT USE DETERGENTS.** Allow to air dry. Do not store canvas wet or in an unventilated, moist area.

### Special Cleaning Problems

For heavily soiled fabric, remove the top from the frame. Soak the fabric for approximately 20 minutes in a solution that has been mixed to the following proportions:

- 1/2 cup (4 ounces) of non-chlorine bleach
- 1/4 cup of mild soap like Ivory Snow, Dreft™ or Woolite™
- One gallon of lukewarm water (water should be no more than 100°F [37.8°C])

Allow the fabric to soak until the non-chlorine bleach has killed the mildew and the stains can be brushed out with a soft scrub brush. Rinse the fabric thoroughly in cold water to remove all of the solution.

This may require rinsing several times. Incomplete rinsing can also cause deterioration of sewing threads and prohibit the fabric from being properly retreated. Do not soak excessively, since the non-chlorine bleach can deteriorate the sewing threads. Allow the fabric to air dry completely.

Sunbrella may also be dry cleaned. **DO NOT STEAM PRESS OR DRY IN AN ELECTRIC OR GAS DRYER.** Sunbrella is thermoplastic, or heat-sensitive. Excessive heat can damage and shrink the fabric.

These methods of cleaning may remove part of the water and stain repellency that was applied to the fabric during its manufacture. The fabric should receive an application of an air curing treatment such as “303 HIGH TECH FABRIC GUARD” after it has been cleaned.

## OTHER CANVAS COMPONENTS

### Clear Vinyl “Isinglass”

The clear vinyl “isinglass” used in side curtains, aft curtains and visors is very reactive to heat and cold. Carefully unroll the vinyl in cold weather to avoid cracking. Keep vinyl side curtains from touching the bows (tubing) to prevent burning the vinyl. If boat is stored with top, side curtains and aft curtain in place, heat buildup inside of the boat may discolor the vinyl.

Use a soft, clean cloth with a solution of Ivory or Lux soap, liquid or flakes, and lukewarm water. Never use any harsh or abrasive cleanser; these types of cleaners will scratch the glass. To keep the vinyl soft and flexible, regularly apply UV screening agent such as “303 PROTECTANT.”

- Do not fold or wrinkle curtains; roll smoothly when storing.
- NEVER store the isinglass wet or in an unventilated, moist area.
- Always roll the glass instead of folding.
- Handle the isinglass carefully. It is soft and very prone to scratching.

### Zippers

When zippers are new, they can be more difficult to zip than when “used.” Zip carefully without forcing. They will loosen with use. Keep the zippers clean. A zipper lubricant may be used to help new zippers and to maintain long trouble-free service. The most vulnerable part of the zipper is where they start. Use care when starting zipper to prevent damage.

### Snap Fasteners

Fasteners should be unsnapped as close to the button as possible. Never remove canvas by pulling roughly on one edge of the material. This can damage the canvas and the fasteners. To prevent snaps from becoming difficult to unsnap, keep them clean and use lubricants such a small amount of Vaseline®, Chapstick®, WD-40®, silicone spray, etc. The most common recommendation is to rub candle wax or paraffin around the stud or inside the socket. Whichever method is used, make sure you clean up any excess so the lubricant does not stain the canvas or any other surfaces it may contact.

## WINDSHIELD

To keep the windshield clean, use a non-abrasive glass cleaner applied with a soft cloth. Do not use harsh detergents, solvents, chemicals or dry cloths. These items will scratch the surface.

## BILGE

Keep the bilge area as clean as possible. Use a vacuum cleaner to remove debris from the bilge area. Oil and greasy dirt will accumulate over time and normally can be removed using soap and water. If necessary, consult your authorized Cobalt dealer for recommendations on special bilge cleaning and absorption products.

## MARINE GROWTH

If marine growth is a problem in your boating area, it may be necessary to apply anti-fouling paint to the hull to slow growth and prevent gelcoat damage. Consult your authorized Cobalt dealer for recommendations.



# INTERIOR/EXTERIOR CARE

## STATIONARY ARCH WITH AWLGRIP TOPCOAT

Your Cobalt boat may be equipped with a fixed, stationary arch with Awlgrip Topcoat.

It is difficult for dirt, grime and grease to adhere to Awlcraft 2000 Topcoat; however, over time, a buildup of dirt, grease and other contaminants can cause the finish to appear dull.

Maintaining your topcoat with a combination of Awlwash and Awlcare will deliver the best results.

The mirror-like gloss can be easily maintained by following these simple rules.

### DO:

1. Wash the surface regularly with Awlwash 73234 and water. Regular cleaning will avoid buildup, which can slowly attack the topcoat, prematurely aging the coating.
2. Use only mild solvents to remove stubborn stains. Awlprep T0008, mineral spirits, xylene, kerosene and diesel fuel are acceptable for use on Cobalt's topcoat.  
Apply solvents with soft, clean cloths. Wipe up solvent quickly. Do not allow solvent to dry on the surface or puddle and soak into the surface. Wash these areas with mild detergents and water to remove solvent residue.
3. Always thoroughly rinse all surfaces with fresh water after cleaning with detergents or solvents. Latent solvent residue can attack the topcoat, while detergent residue will attract dirt.
4. Use distilled white vinegar and hot water to remove stubborn salt stains.
5. Use Awlcare 73240 by hand only to remove stubborn diesel soot stains.

### DO NOT:

1. Do not wax.

#### General:

Wax buildup ages and yellows very rapidly, creating the need to maintain the wax and causing the topcoat to appear yellow. Wax buildup also collects dirt, increasing maintenance.

Waxing will help maintain the gloss, especially those which have been buffed or polished. Remember, waxing leads to having to maintain the wax.

Do not wax areas unless they are dull or hazed.

2. Do not use abrasives, scratch pads or polishing compounds. Scratching the surface gives dirt a place to cling while wearing out the resin layer. Using abrasives of any kind will reduce the overall life of the finish and voids the Awlgrip Limited Warranty.
3. Do not allow contact between the topcoat and teak cleaners. Most teak cleaners contain acids or caustic agents that stain and discolor the topcoat.
4. Do not use strong solvents (e.g., lacquer thinner, M.E.K., acetone) to clean the topcoat.
5. Do not allow wet equipment (e.g., seat cushions, coils of line, sails, sail covers, coolers) to trap and hold moisture against the topcoat. This condition can result in blistering or delamination of the Awlgrip topcoat.
6. Do not use acrylic Teflon®\* coatings over an Awlcraft 2000 finish. Use of these coatings voids the Awlgrip Limited Warranty.
7. Do not "shrink wrap" or tightly bind the topcoat surfaces with plastic wrappings.

\* Teflon is a registered trademark of E.I. du Pont de Nemours and Company.

When tarping a boat for storage, the cover system should be ventilated to allow the coating system to “breathe.” Covers and tarps, whether synthetic or natural fiber, should not be pulled tight to surfaces painted with Awlcraft 2000 Topcoat. This condition can trap and hold moisture on the surface and may result in loss of gloss, blistering or delamination of the topcoat.

Caution should also be used to ensure the tarp does not chafe against the Awlcraft 2000 surface. Such chafing, especially when accompanied by airborne dirt, can abrade the surface and cause premature loss of gloss.



# MAINTENANCE AND TROUBLESHOOTING

## SCHEDULED MAINTENANCE AND SERVICE

Your Cobalt boat may not include all of the features described in this section based on the options available and how your boat was built. If you are in question of the features on your boat, contact your authorized Cobalt dealer.

### Maintenance Schedule

<b>⚠ WARNING</b>
<p><b>The Teleflex® steering system must have all attaching hardware, bolts and nuts retorqued according to manufacturer's specifications after a few hours of operation and at regular intervals thereafter. Loose or missing hardware may cause failure of the steering system, resulting in injury or death. Please have your authorized Cobalt dealer service the steering system at intervals.</b></p>

Use the checks and maintenance information outlined in the section along with service information contained within the individual component operator's manuals supplied with your boat. It is extremely important that you read and understand the periodic maintenance tasks outlined in your operator's manuals (propulsion unit, generator and other accessories) because those maintenance tasks are not repeated in this manual.

Use the following chart to establish your maintenance routine. Detailed information concerning the task is listed in this section.

Frequency	Task
Break-In	Refer to propulsion unit operator's manual and the generator operator's manual, if equipped.
Before Every Use	Test operation of carbon monoxide detectors.
	Check fluid levels.
	Check seacocks for leaks and ensure handles are secure.
	Check seawater strainers for leaks and accumulation of debris.
	Check generator's fuel/water separator, if equipped.
	Check exhaust system for leaks.
	Check fuel system for leaks.
	Check fire extinguisher.
	Check battery charge.
Check equipment fasteners.	

Frequency	Task
Every 50 Hours	Clean seawater strainers if equipped.
	Inspect propellers for damage.
Every 100 Hours	Test for proper operation of the ignition safety switch.
	Clean bilge area.
Monthly	Test GFCI outlets, if equipped.
	Check self-sacrificing anodes.
Quarterly	Have your authorized Cobalt dealer perform scheduled maintenance as outlined in this section.

### Break-In

Careful break-in allows internal engine components to “seat” properly, resulting in maximum engine life and performance. Refer to the propulsion unit and generator (if equipped) operator’s manuals for manufacturers’ break-in requirements.

### Before Each Use

1. Test for proper operation of the carbon monoxide detector (if equipped); refer to the carbon monoxide detector operator’s manual.
2. Check fluid levels of freshwater tank, waste holding tank (if equipped) and trim tab reservoir.
3. Check the air conditioning and generator (if equipped) seacocks and hoses for leaks. If you notice a leak, see your authorized Cobalt dealer.

### CAUTION

- **Seacocks can only be replaced when the boat is out of the water.**
- **Make sure a seacock is in the CLOSED position before replacing a hose.**

4. Check the air conditioning and generator seawater strainers for leaks and accumulation of debris.
  - If a hose is leaking or damaged, close the appropriate seacock. Consult your authorized Cobalt dealer for repairs.

- If debris is seen within the container, close the appropriate seacock and remove the strainer cover. Lift strainer from container and thoroughly clean. If the container is full of sediment, remove the plug at the bottom of the container and allow water to drain into the bilge. Remove the container and clean any sediment. Install the container and plug. Install strainer in container and secure cover. Open the seacock and check for leaks.

### CAUTION

**Seacock must be in the CLOSED position before servicing a strainer.**

5. Start engine(s) and the generator (if equipped). Check all exhaust systems for leaks. If you notice a leak, see your authorized Cobalt dealer.
6. Check all fuel lines and connections at fuel tanks, engines and the generator for leaks. If you detect a fuel leak, immediately see your authorized Cobalt dealer.

### DANGER

**Avoid the risk of fire or explosion. DO NOT operate your boat if a fuel leak is detected. All fuels are combustible. A fuel leak must be repaired before starting the engine(s) or the generator (if equipped).**

7. Check the portable and automatic fire extinguishers for proper charge.
8. Check the battery charge of both engine batteries. Be sure that the batteries can start the engine(s) and the generator, if equipped, before proceeding on your cruise.
9. Check equipment for loose or missing fasteners. Be sure all fasteners are installed and properly tightened before operating equipment.

### Every 50 Hours

1. Be sure to clean seawater strainers as described in **Before Each Use**, Step 3.

# MAINTENANCE AND TROUBLESHOOTING

2. Check propellers for damage. If bends, cracks or other damage are found, consult your authorized Cobalt dealer for service. Do not continue to use badly damaged propellers. Using damaged propellers may damage the drive unit(s) within time.

## Every 100 Hours

Clean the bilge area. Make sure all drain passageways are clear. Refer to **Bilge** in *Section 5* for cleaning instructions.

## Monthly

**⚠ DANGER**

**Avoid the risk of injury or drowning. The ignition safety switch and lanyard are to prevent the boat from becoming a runaway if the operator is accidentally thrown away from the helm. With the engine(s) running, pull the lanyard off the ignition safety switch. Engine(s) must stop running. If the engine or engines do not stop running, immediately see your authorized Cobalt dealer for service.**

1. Test the GFCI outlet circuit breaker feature if equipped. Push the TEST button on each outlet. Power should be interrupted to all the outlets onboard. Press the RESET button to restore power. If power is not interrupted, consult your authorized Cobalt dealer.

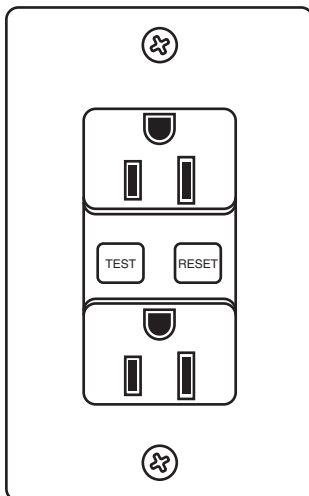

COB\_0079\_A

2. Check condition of all self-sacrificing anodes. If anode shows deterioration of 50% or more, it must be replaced. Refer to the propulsion unit operator's manual for additional information.

## Quarterly

Have your authorized Cobalt dealer perform the following scheduled maintenance:

1. Clean the freshwater filter.
2. Fill, pressurize and inspect the freshwater system for leaks and proper component operation.
3. Inspect the steering, shift and throttle systems for proper operation.
4. Check all batteries for proper electrolyte level.
5. Check trim tab pump fluid level.

## UNSCHEDULED MAINTENANCE

A problem with a piece of equipment can occur at any time. Be aware of a malfunction. Have a problem serviced immediately by your authorized Cobalt dealer.

### Engine/Propulsion/Cooling System

If a problem occurs with your engine, propulsion unit or the cooling system between the scheduled maintenance cycle, immediately notify your authorized Cobalt dealer. Do not allow a problem to go unattended. By doing so, a minor repair could become a major overhaul.

### Electrical System

Have your authorized Cobalt dealer repair all electrical problems. An electrical problem must be treated seriously.

**⚠ DANGER**

**Avoid fire or explosion. Whenever checking for electrical problems, use extreme caution. Fuel and fumes are extremely flammable and explosive.**

## Fuel System

Do not operate your boat knowing you have a fuel system problem. Upon discovery of a fuel system problem, immediately notify your authorized Cobalt dealer for repair.

### WARNING

**Avoid fire or explosion. Whenever checking for electrical problems, use extreme caution. Fuel and fumes are extremely flammable and explosive. DO NOT operate your boat when a fuel leak is detected. All fuels are combustible. A fuel leak must be repaired before starting the engine(s) or the generator (if equipped).**

## Water System (if equipped)

### Fresh Water

Before departing on a cruise, check the level of fresh water onboard. Fill the freshwater tank and verify for proper operation of the freshwater system. If a problem is found, have the problem repaired at your earliest convenience.

### *Cleaning and Disinfecting the Freshwater System*

For potable (drinking) water, follow these steps to disinfect the water tank and system before the first use and prior to the boating season every year. Repeat process as often as needed.

These steps involve filling the freshwater tank with a solution of household bleach and running the solution through each faucet, and then letting it stand for at least three hours. Finally, flush the system once or twice to remove the taste and smell.

1. Start with a nearly full freshwater tank.
2. Turn the water heater off (if applicable) and let the water cool.
3. Dilute 4 tablespoons of household bleach for each 10 gallons of tank capacity into a gallon of water.
4. Add the chlorine/water solution to the water tank. (Never pour straight bleach into the freshwater tank.)

5. One faucet at a time, let the chlorinated water run through them for one or two minutes. (Hot water will take longer due to hot water tank.) You should be able to smell the chlorine. (Make sure you are using the water pump and not an external water supply.)
6. Top off the freshwater tank and let stand for at least three hours – overnight is better.
7. Completely drain the system by flushing the faucets for several minutes each. Open the freshwater tank drain valve to speed up emptying the tank and open the hot water tank drain plug (if applicable) and drain until it is empty.
8. Close all valves and faucets and install all drain plugs.
9. Fill the water tank with fresh water.
10. Flush each faucet for several minutes each, repeating until the tank is again empty. (Make sure you are using the water pump and not an external water supply.)
11. Fill the tank again. The water should now be safe to drink. If the chlorine odor is too strong, you can repeat the freshwater flush.

### Gray Water

Periodically check the level of waste water in the waste tank. Have your waste tank pumped out when needed and be sure that the waste system is always operating properly.

## LIFTING THE BOAT

To prevent structural damage to your Cobalt boat, the proper procedure must be used when lifting your boat. Only use appropriate style lifting slings to lift the boat. Slings must be used to lift the boat.

### Using Lifting Slings

The only recommended method of removing the boat from the water is to use a trailer designed for your boat or lifting slings. Slings must be the flat, wide-belted type. Do not use cable-type slings. The spreader bars used with the slings must be wide enough to avoid pressure to the gunwales.

# MAINTENANCE AND TROUBLESHOOTING

If your Cobalt boat has sling location decals on each side of the hull to indicate where each sling should be located, use them to position the slings. If your boat does not have decals, contact your authorized Cobalt dealer to identify the proper location for slings. Slings may need to be adjusted forward or aft for your particular boat.

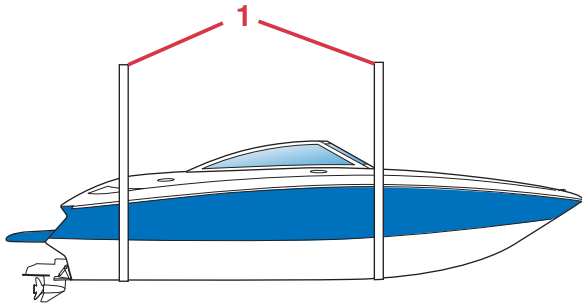

COB\_0080\_A

1 – Flat, wide-belted sling

## Storage Cradle

Only use a storage cradle or the trailer designed for your boat to store your boat when it is not in the water. A storage cradle or your boat's trailer will provide proper support and prevent stress on the hull.

Position the storage cradle as close to the sling tag locations as possible. Use caution not to damage any underwater fittings.

The storage cradle must completely touch the hull for proper support. Avoid any gaps between the cradle and the hull.

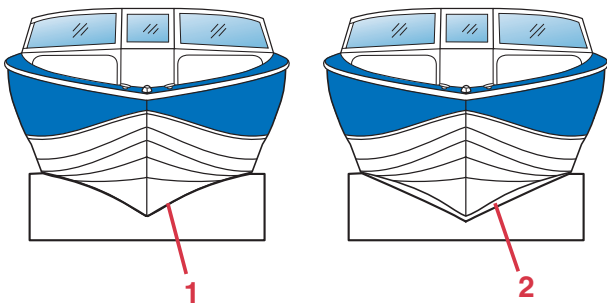

COB\_0081\_A

1 – Hull completely on cradle — right  
2 – Gap between hull and cradle — wrong

Store your Cobalt boat on a storage cradle with the bow slightly elevated, the same attitude as if the boat were floating at rest. If the boat is stored with the bow down, moisture will not be able to move to the engine bilge area and out of the boat. Remove the transom drain plug.

Be sure that all compartments in the bilge completely drain. Mold and mildew may form as a result of the inability of moisture to escape.

## STORAGE/WINTERIZATION

Preparing for winter lay-up is important. In frigid zones, be particularly attentive to items that can be damaged by freezing. Freeze damage is not covered by warranty.

The following items require special attention for winterization. Your Cobalt boat may not include all the features described. Have your authorized Cobalt dealer perform winterization procedures for the following:

- Engine cooling and exhaust systems
- Fuel system
- Batteries
- Air conditioning
- Generator and muffler
- Waste water system
- Freshwater system
- Gray water system
- Cockpit heater

After the boat has been properly positioned on a storage cradle, thoroughly wash the hull, deck and interior compartments. Allow a couple of days of air drying before covering the boat, store all cushions in the OPEN position and open all storage areas. This will help prevent mold/mildew from forming. Perform preventive maintenance to the interior and exterior of your boat following the information in *Section 5, Interior and Exterior Care*.

Cover the boat with the mooring cover. If a temporary poly cover, such as shrink wrap, is used, your authorized Cobalt dealer will install several vents to provide adequate ventilation to prevent mold or mildew.



**NOTICE:** For stowage, we recommend an optional mooring cover of 100% SharkSkin™ polyester. **DO NOT** use your tonneau cover for long-term storage. These canvases were not designed for long-term storage and do not provide good protection for your boat. Adequate ventilation is not possible and mold/mildew will form.

For more information on appropriate covering for long term storage, see your authorized Cobalt dealer.

### Reactivating the Boat After Storage

Have your authorized Cobalt dealer prep your boat for the upcoming boating season. There are many systems that require special attention to ensure your boat is in proper operating condition.

- Carbon monoxide detector(s), if equipped
- Fuel and exhaust systems
- Engine's cooling, exhaust and lubrication systems
- Air conditioning
- Generator and muffler
- Freshwater system
- Waste water system
- Gray water system
- Batteries

It is very important that all fuel systems and exhaust systems be thoroughly inspected and repaired, if necessary, before operating the boat. Also, any accessory exhaust systems must be in proper operating condition.

Be sure to check all onboard equipment for loose or missing fasteners. Do not operate the equipment if the fasteners are loose or missing.

### **DANGER**

**Avoid the risk of fire or explosion. Inspect the fuel system. Failure to inspect the fuel system and allow fuel leaks to go undetected will contribute to a fire or explosion hazard.**

### **DANGER**

**Avoid the possibility of injury or death. Exposure to carbon monoxide (CO) can cause severe injury or death. All gasoline engines produce CO. CO is colorless, odorless and dangerous. Direct and prolonged exposure to CO will cause brain damage or death. Signs of exposure to CO include nausea, dizziness and drowsiness. Avoid exposing your passengers or yourself to carbon monoxide.**

### **WARNING**

**The extended swim platform must be attached to the boat when it is in use. The boarding ladder is attached to the boarding platform. The removable feature is for boat storage only.**

### Cockpit Heater

To winterize the optional cockpit heater, remove the two 5/8-inch cockpit heater hoses from the engine. Pump antifreeze into one hose until entire heater system is filled.



# MAINTENANCE AND TROUBLESHOOTING

## TROUBLESHOOTING

The following chart will assist you in locating and repairing a minor problem. Have your authorized Cobalt dealer assist you with service issues.

Your Cobalt boat is equipped with an ignition safety switch located at the helm. Make sure the lanyard is installed with the switch holding the lanyard in place. If you are experiencing any problems with the safety switch contact your authorized Cobalt dealer.

### DANGER

**Avoid the risk of fire, explosion, electrocution or bodily injury. Fuels are extremely explosive and flammable. Use extreme caution when handling fuels.**

- **Whenever checking for electrical problems use extreme caution.**
- **Battery acid can cause blindness if splashed in eyes, burning of skin. Wear protective gear.**
- **Disconnect battery cables at the battery before making checks or adjustments around the engines and electrical components.**

## Engine

For further troubleshooting information other than given here, refer to the propulsion unit operator's manual.

Symptom	Possible Cause
Engine will not crank	Lanyard – install on ignition safety switch.
	Battery switches – turn switches to ON position.
	Shift position – check to see that levers are in START or NEUTRAL position.
	Battery condition – verify batteries are fully charged.
	Starter connections – check connections and tighten. If solenoid clicks when attempting to start engine, check battery connections. If condition persists, see your authorized Cobalt dealer.
	Engine circuit breaker – verify breaker is in operating position.
	Faulty ignition switch – see your authorized Cobalt dealer.
	Engine problem – see your authorized Cobalt dealer.
Engine cranks but will not start	Fuel valves – be sure fuel valves are open.
	Contaminated fuel – see your authorized Cobalt dealer.
	Engine problem – see your authorized Cobalt dealer.
Low starter speed	Weak or bad battery – see your authorized Cobalt dealer.
Engine runs erratically	See your authorized Cobalt dealer.
Engine vibrates	Propeller condition – shut off engines. Check for bent, broken or damaged propeller. Check for weeds on propeller.
	Engine problem – see your authorized Cobalt dealer.
Engine runs but boat makes little or no progress	Fouled or damaged propeller – shut off engines. Check for weeds on propeller, bent or broken propeller. See your authorized Cobalt dealer.

Symptom	Possible Cause
Performance Loss	Throttles not fully open – check to see that both throttles open fully at engines.
	Improper fuel – fill tanks with correct fuel.
	Overheating – immediately turn off the engines and contact your authorized Cobalt dealer.
	Boat overloaded – reduce load.
	Boat trim – distribute boat load evenly.
	Improper propeller selection – see your authorized Cobalt dealer.
	Excessive bilge water – check for excessive water, drain bilge.
	Boat hull condition – clean if marine growth is present.

# MAINTENANCE AND TROUBLESHOOTING

## Electrical

### CAUTION

**Correct a problem with the electrical system before resetting a circuit breaker. If the breaker continues to trip, see your authorized Cobalt dealer.**

Symptom	Possible Cause
Electrical component will not function	Circuit breaker tripped or in the OFF position – correct the problem and reset; turn circuit breaker on.
Dim or no lights	Circuit breaker tripped or in the OFF position – correct the problem and reset; turn circuit breaker on.
	Battery discharged – charge battery.
Generator will not start	Battery switch in the OFF position – turn switch to the ON position.
	Engine problem – see your authorized Cobalt dealer.
No AC power	Circuit breakers tripped or in the OFF position – correct the problem and reset the shore power inlet breaker or the breaker on the cabin distribution panel.
	Make sure shore/generator selector switch is positioned correctly.
	Ground fault circuit interrupter tripped – reset button on the outlet and test. If problem exists – see your authorized Cobalt dealer.

## Plumbing

Symptom	Possible Cause
No water at sink	Freshwater pump circuit breaker tripped or in the OFF position – correct the problem and reset; turn circuit breaker on.
	Freshwater tank empty.
	Freshwater pump defective – see your authorized Cobalt dealer.
	Filter plugged – clean filter located at the tank under mid-berth.
Low water pressure at sink	Damaged freshwater pump, restriction or obstruction in water line – see your authorized Cobalt dealer.
Head will not flush	Head circuit breaker tripped or in OFF position – correct the problem and reset; turn circuit breaker ON.
	Line to waste tank blocked – see your authorized Cobalt dealer.

**NOTES**



# REFERENCE AND FORMS

## OPERATION QUICK REFERENCE

Your safety, the safety of your passengers and other boats are among your responsibilities as operator of the boat. Your boat must be in compliance with USCG safety equipment regulations.

### Before Launching

If pulling from storage, de-winterize the engine(s); consult your authorized Cobalt dealer if necessary.

- Install drain plug.
- Have enough PFDs for every person onboard.
- Make sure you have enough fuel.
- Verify the batteries are fully charged.
- Check all fluid levels. Refer to the propulsion unit operator's manual or consult your authorized Cobalt dealer.
- Check weather conditions.
- Be sure the lights, horn, bilge pumps and other electrical equipment are in operating condition.
- Be sure the fire extinguisher, signaling devices and other emergency gear are onboard and in proper operating condition.

### Pre-Operation

- Test operation of carbon monoxide detector.
- Open all seacocks and check for leaks.
- Check seawater strainers for leaks and accumulation of debris.
- Check generator fuel/water separator.
- Open windows, doors and hatches.
- Check that no fuel, oil or water is leaking or has leaked into the bilge compartment.
- Check all hoses and connections for leakage and damage.
- Check that the steering system operates properly.
- Do not overload your boat.

**Starting Engines**

- Operate bilge blowers for at least four minutes before starting the engines or generator.
- Turn battery selector switches to ON.
- Attach lanyard to the ignition safety switch and the operator.
- Make sure both shift levers are in the NEUTRAL position.
- Move both throttle levers to the IDLE position.
- Start both engines. Operate the engines at 1000 RPM (gas engines), 1400 RPM (diesel engines) and check if oil pressure is within specified range. Make sure the water pressure gauges start to indicate pressure in 15 seconds or less after starting. If not, shut off the engines and verify the engines are getting cooling water.

After engines are warmed up, verify water temperature is within its specified range.

**Casting Off**

- Allow enough room between the boat and the dock to swing the boat away from the dock.
- Retrieve all mooring lines and fenders.
- Proceed slowly and sound a long blast to alert other boaters you are leaving.

**During Operation**

- Check gauges frequently for signs of abnormal operation.
- Check for excessive vibration.
- Monitor your fuel supply.
- Verify charging of the batteries.

**Returning to Port**

- Come to a stop a short distance from the dock, then proceed slowly.
- Have your fenders, mooring lines and the crew ready.

**Stopping the Engines**

- Slowly bring the throttle levers to the IDLE position.
- Move the shift levers to the NEUTRAL position.
- Turn the ignition keys to the OFF position.

**After Boating**

- Turn off your navigational lights, leave the anchor light on, if necessary.
- Check the bilge for gas fumes and water. Operate the blower and bilge pump, if necessary.
- Fill fuel tanks to prevent moisture due to condensation.
- To prevent marine growth from accumulating on the hydraulic cylinder shafts, make sure trim tabs are up and propulsion unit drives are in the full IN position.
- Lock ignition key switch and remove the ignition keys.
- Stow and secure all equipment.
- Pump bilges dry with manual switch.
- Close all water inlet seacocks.
- If possible, inspect the hull and propellers for damage.
- Check for fuel, oil and water leaks.
- Clean any spills, stains or moisture from the boat. Inspect sea strainers.
- Turn battery selector switches to the OFF position.
- Turn breakers on electrical panel to the OFF position.
- Remove any food, garbage and wet gear from the boat.
- Secure lockers, hatches and canvas as equipped.







# REFERENCE AND FORMS

## FLOAT PLAN

Copy this page and fill out the copy before boating. Leave the filled out copy with a reliable person who can be depended upon to notify the USCG or other rescue organization, should you not return as scheduled. Do not file this plan with the USCG.

Name \_\_\_\_\_ Telephone \_\_\_\_\_

Description of Boat: Type \_\_\_\_\_ Color \_\_\_\_\_ Trim \_\_\_\_\_

Registration Number \_\_\_\_\_

Length \_\_\_\_\_ Length \_\_\_\_\_ Length \_\_\_\_\_

Other Info. \_\_\_\_\_

Persons Aboard: Name, Age, Address & Telephone

\_\_\_\_\_  
\_\_\_\_\_  
\_\_\_\_\_  
\_\_\_\_\_

Engine Type: \_\_\_\_\_ HP \_\_\_\_\_

No. of Engines: \_\_\_\_\_ Fuel Capacity: \_\_\_\_\_

Survival Equipment:

PFDs \_\_\_\_\_ Flares \_\_\_\_\_ Mirror \_\_\_\_\_

Smoke Signals \_\_\_\_\_ Flashlight \_\_\_\_\_ Food \_\_\_\_\_

Paddles \_\_\_\_\_ Water \_\_\_\_\_ Anchor \_\_\_\_\_

Raft or Dinghy \_\_\_\_\_ EPIRB \_\_\_\_\_

Radio: Yes \_\_\_\_\_ No \_\_\_\_\_ Type \_\_\_\_\_ Freq \_\_\_\_\_

Destination \_\_\_\_\_ Est. Time of Arrival \_\_\_\_\_

Expect to Return By \_\_\_\_\_

Auto Type \_\_\_\_\_ License No. \_\_\_\_\_ Parked \_\_\_\_\_

If not returned by \_\_\_\_\_ call the Coast Guard, or \_\_\_\_\_

(Local Authority). Coast Guard Telephone Number: \_\_\_\_\_

Local Authority Telephone Number: \_\_\_\_\_

## BOAT INFORMATION

Store this information in a safe place other than on your boat.

Owner \_\_\_\_\_

Home Port \_\_\_\_\_

Boat Name \_\_\_\_\_

Selling Dealer \_\_\_\_\_

Port Ignition Key Number \_\_\_\_\_ Starboard Ignition Key Number \_\_\_\_\_

Cabin Key Number \_\_\_\_\_

Registration Number \_\_\_\_\_ State \_\_\_\_\_

Hull Serial Number \_\_\_\_\_ Warranty Registration Date \_\_\_\_\_

Engine Make and Model Number \_\_\_\_\_

Port Engine Serial Number \_\_\_\_\_ Starboard Engine Serial Number \_\_\_\_\_

Port Drive Serial Number \_\_\_\_\_ Starboard Drive Serial Number \_\_\_\_\_

Propeller Size \_\_\_\_\_

Generator Model Number \_\_\_\_\_ Serial Number \_\_\_\_\_

VHF Radio Make and Model Number \_\_\_\_\_ Serial Number \_\_\_\_\_

GPS Make and Model Number \_\_\_\_\_ Serial Number \_\_\_\_\_

Radar Make and Model Number \_\_\_\_\_ Serial Number \_\_\_\_\_

DVD Make and Model Number \_\_\_\_\_ Serial Number \_\_\_\_\_

Stereo Make and Model Number \_\_\_\_\_ Serial Number \_\_\_\_\_

TV, Cabin Make and Model Number \_\_\_\_\_ Serial Number \_\_\_\_\_

TV, Mid-berth Make and Model Number \_\_\_\_\_ Serial Number \_\_\_\_\_

Subwoofer Make and Model Number \_\_\_\_\_ Serial Number \_\_\_\_\_

# REFERENCE AND FORMS

## WARRANTY TRANSFER FORM

Date: \_\_\_\_\_

Cobalt Serial Number: \_\_\_\_\_

**Original Owner (Seller):** \_\_\_\_\_

Address: \_\_\_\_\_

\_\_\_\_\_

Home Phone: \_\_\_\_\_ Work Phone: \_\_\_\_\_

Email Address: \_\_\_\_\_

**New Owner (Purchaser):** \_\_\_\_\_

Address: \_\_\_\_\_

\_\_\_\_\_

Home Phone: \_\_\_\_\_ Work Phone: \_\_\_\_\_

Email Address: \_\_\_\_\_

Submitted by:

Dealer: \_\_\_\_\_

Individual: \_\_\_\_\_

Fax this form to 1-620-325-2190 or mail to Cobalt Boats, 1715 N. 8th Street, Neodesha, KS 66757.

**NOTES**